



Dear customer

ROHM Co., Ltd. ("ROHM"), on the 1st day of April, 2024,  
has absorbed into merger with 100%-owned subsidiary of LAPIS Technology Co., Ltd.

Therefore, all references to "LAPIS Technology Co., Ltd.", "LAPIS Technology"  
and/or "LAPIS" in this document shall be replaced with "ROHM Co., Ltd."

Furthermore, there are no changes to the documents relating to our products other than  
the company name, the company trademark, logo, etc.

Thank you for your understanding.

ROHM Co., Ltd.  
April 1, 2024

**Not Recommended for  
New Design**

Dear customer

LAPIS Semiconductor Co., Ltd. ("LAPIS Semiconductor"), on the 1<sup>st</sup> day of October, 2020, implemented the incorporation-type company split (shinsetsu-bunkatsu) in which LAPIS established a new company, LAPIS Technology Co., Ltd. ("LAPIS Technology") and LAPIS Technology succeeded LAPIS Semiconductor's LSI business.

Therefore, all references to "LAPIS Semiconductor Co., Ltd.", "LAPIS Semiconductor" and/or "LAPIS" in this document shall be replaced with "LAPIS Technology Co., Ltd."

Furthermore, there are no changes to the documents relating to our products other than the company name, the company trademark, logo, etc.

Thank you for your understanding.

LAPIS Technology Co., Ltd.

October 1, 2020

**Not Recommended for  
New Design**

# ML610Q435/ML610Q436

8-bit Microcontroller with a Built-in LCD driver

## GENERAL DESCRIPTION

This LSI is a high-performance 8-bit CMOS microcontroller into which rich peripheral circuits, such as real-time clock, synchronous serial port, UART, I<sup>2</sup>C bus interface (master), melody driver, battery level detect circuit, RC oscillation type A/D converter, 12-bit successive approximation type A/D converter, and LCD driver, are incorporated around 8-bit CPU nX-U8/100. The CPU nX-U8/100 is capable of efficient instruction execution in 1-instruction 1-clock mode by 3-stage pipe line architecture parallel processing. The Flash ROM that is installed as program memory achieves low-voltage low-power consumption operation (read operation) equivalent to mask ROM and is most suitable for battery-driven applications. The on-chip debug function that is installed enables program debugging and programming.

## FEATURES

- CPU
  - 8-bit RISC CPU (CPU name: nX-U8/100)
  - Instruction system: 16-bit instructions
  - Instruction set: Transfer, arithmetic operations, comparison, logic operations, multiplication/division, bit manipulations, bit logic operations, jump, conditional jump, call return stack manipulations, arithmetic shift, and so on
  - On-Chip debug function
  - Minimum instruction execution time
    - 30.5 μs (@32.768 kHz system clock)
    - 0.24 4μs (@4.096 MHz system clock)
- Internal memory
  - Internal 96KByte Flash ROM (48K×16 bits) (including unusable 1KByte TEST area)
  - Internal 2KByte Data RAM (2048×8 bits), 1KByte Display Allocation RAM (1024 x 8bit)
  - Internal 192Byte RAM for display
- Interrupt controller
  - 2 non-maskable interrupt sources (Internal source: 1, External source: 1)
  - 23 maskable interrupt sources (Internal sources: 19, External sources: 4)
- Time base counter
  - Low-speed time base counter ×1 channel  
Frequency compensation (Compensation range: Approx. –488ppm to +488ppm. Compensation accuracy: Approx. 0.48ppm)
  - High-speed time base counter ×1 channel
- Watchdog timer
  - Non-maskable interrupt and reset
  - Free running
  - Overflow period: 4 types selectable (125ms, 500ms, 2s, and 8s)
- Timers
  - 8 bits × 4 channels (16-bit configuration available)
- 1 kHz timer
  - 10 Hz/1 Hz interrupt function



- Capture
  - Time base capture × 2 channels (4096 Hz to 32 Hz)
- PWM
  - Resolution 16 bits × 1 channel
- Real time clock
  - Year, month, day, day of the week, hour, minute, and second registers
  - Automatic leap year correction
  - Regular interrupts (0.5 sec, 1 sec, 1 minute, 1 hour)
  - Alarm interrupt × 2 channels (day of the week, hour, minute; month, day hour, minute)
- Synchronous serial port
  - Master/slave selectable
  - LSB first/MSB first selectable
  - 8-bit length/16-bit length selectable
- UART
  - TXD/RXD × 1 channel
  - Bit length, parity/no parity, odd parity/even parity, 1 stop bit/2 stop bits
  - Positive logic/negative logic selectable
  - Built-in baud rate generator
- I<sup>2</sup>C bus interface
  - Master function only
  - Fast mode (400 kbps@4MHz), standard mode (100 kbps@4MHz, 50kbps@500kHz)
- Melody driver
  - Scale: 29 types (Melody sound frequency: 508 Hz to 32.768 kHz)
  - Tone length: 63 types
  - Tempo: 15 types
  - Buzzer output mode (4 output modes, 8 frequencies, 16 duty levels)
- RC oscillation type A/D converter
  - 24-bit counter
  - Time division × 2 channels
- Successive approximation type A/D converter
  - 12-bit A/D converter
  - Input × 2 channels
- General-purpose ports
  - Non-maskable interrupt input port × 1 channel
  - Input-only port × 6 channels (including secondary functions)
  - Output-only port × 3 channels (including secondary functions)
  - Input/output port
    - ML610Q435: 22 channels (including secondary functions)
    - ML610Q436: 14 channels (including secondary functions)

- LCD driver
  - Dot matrix can be supported.
    - ML610Q435: 1024 dots max. (64 seg × 16 com)
    - ML610Q436: 1536 dots max. (64 seg × 24 com)
  - 1/1 to 1/24 duty
  - 1/3 or 1/4 bias (built-in bias generation circuit)
  - Frame frequency selectable (approx. 64 Hz, 73 Hz, 85 Hz, and 102 Hz)
  - Bias voltage multiplying clock selectable (8 types)
  - Contrast adjustment (1/3 bias: 32 steps, 1/4 bias: 20 steps)
  - LCD drive stop mode, LCD display mode, all LCDs on mode, and all LCDs off mode selectable
  - Programmable display allocation function (available only when 1/1~1/8 duty is selected)
- Reset
  - Reset through the RESET\_N pin
  - Power-on reset generation when powered on
  - Reset when oscillation stop of the low-speed clock is detected  
(“A”version(ML610Q435A/Q436A) don’t have the oscillation stop function.)
  - Reset by the watchdog timer (WDT) overflow
- Power supply voltage detect function
  - Judgment voltages: One of 16 levels
  - Judgment accuracy: ±2% (Typ.)
- Clock
  - Low-speed clock: (This LSI can not guarantee the operation without low-speed clock)  
Crystal oscillation (32.768 kHz)
  - High-speed clock:
    - Built-in RC oscillation (500 kHz)
    - Built-in PLL oscillation (8.192 MHz ±TBD%), crystal/ceramic oscillation (4.096 MHz), external clock
  - Selection of high-speed clock mode by software:  
Built-in RC oscillation, built-in PLL oscillation, crystal/ceramic oscillation, external clock
- Power management
  - HALT mode: Instruction execution by CPU is suspended (peripheral circuits are in operating states).
  - STOP mode: Stop of low-speed oscillation and high-speed oscillation (Operations of CPU and peripheral circuits are stopped.)
  - Clock gear: The frequency of high-speed system clock can be changed by software (1/1, 1/2, 1/4, or 1/8 of the oscillation clock)
  - Block Control Function: Power down (reset registers and stop clock supply) the circuits of unused peripherals.
- Guaranteed operating range
  - Operating temperature: -20°C to 70°C
  - Operating voltage:  $V_{DD} = 1.1V$  to 3.6V,  $AV_{DD} = 2.2V$  to 3.6V

- Product name – Supported Function

The line-up of the ML610Q435 and the ML610Q436 is below.

- Chip (Die) -	ROM type	Low-speed oscillation stop detect reset	Operating temperature	Product availability
ML610Q435-xxxWA	Flash ROM	Yes	-20°C to +70°C	Yes
ML610Q435A-xxxWA	Flash ROM	-	-20°C to +70°C	Yes
ML610Q436-xxxWA	Flash ROM	Yes	-20°C to +70°C	Yes
ML610Q436A-xxxWA	Flash ROM	-	-20°C to +70°C	Yes

- 144-Pin plastic LQFP -	ROM type	Low-speed oscillation stop detect reset	Operating temperature	Product availability
ML610Q435A-xxxTC	Flash ROM	-	-20°C to +70°C	Yes
ML610Q436A-xxxTC	Flash ROM	-	-20°C to +70°C	Yes

xxx:ROM code number (xxx of the blank product is NNN)

Q:Flash ROM version

A:Low-speed clock oscillation stop detection reset is disabled always (A version)

WA:Chip (Die)

TC:LQFP

Not Recommended for New Design

**BLOCK DIAGRAM**  
ML610Q435 Block Diagram

Figure 1 show the block diagram of the ML610Q435.  
"\*" indicates the secondary function of each port.

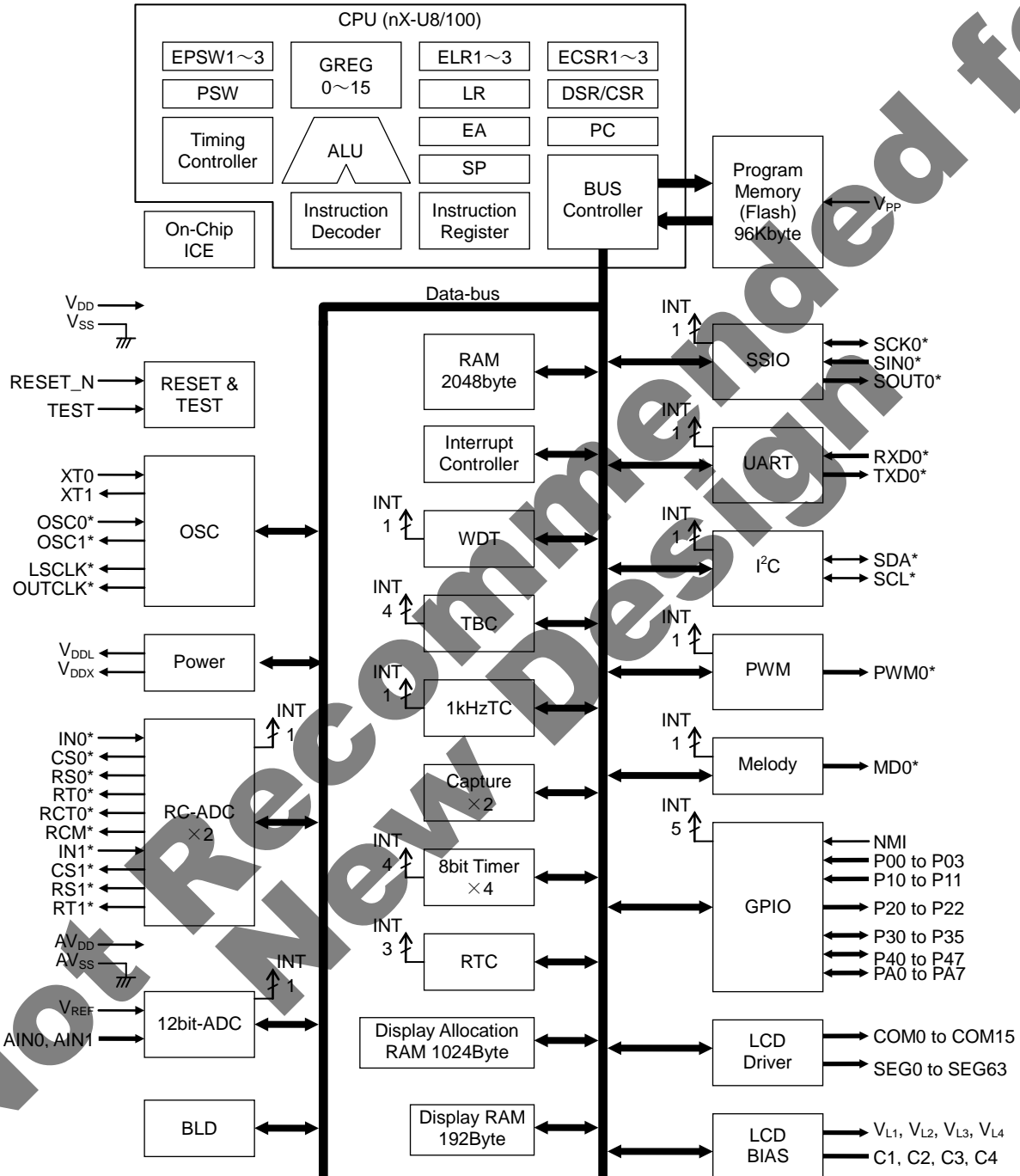

Figure 1 ML610Q435 Block Diagram

ML610Q436 Block Diagram

Figure 2 show the block diagram of the ML610Q436.  
 "\*" indicates the secondary function of each port.

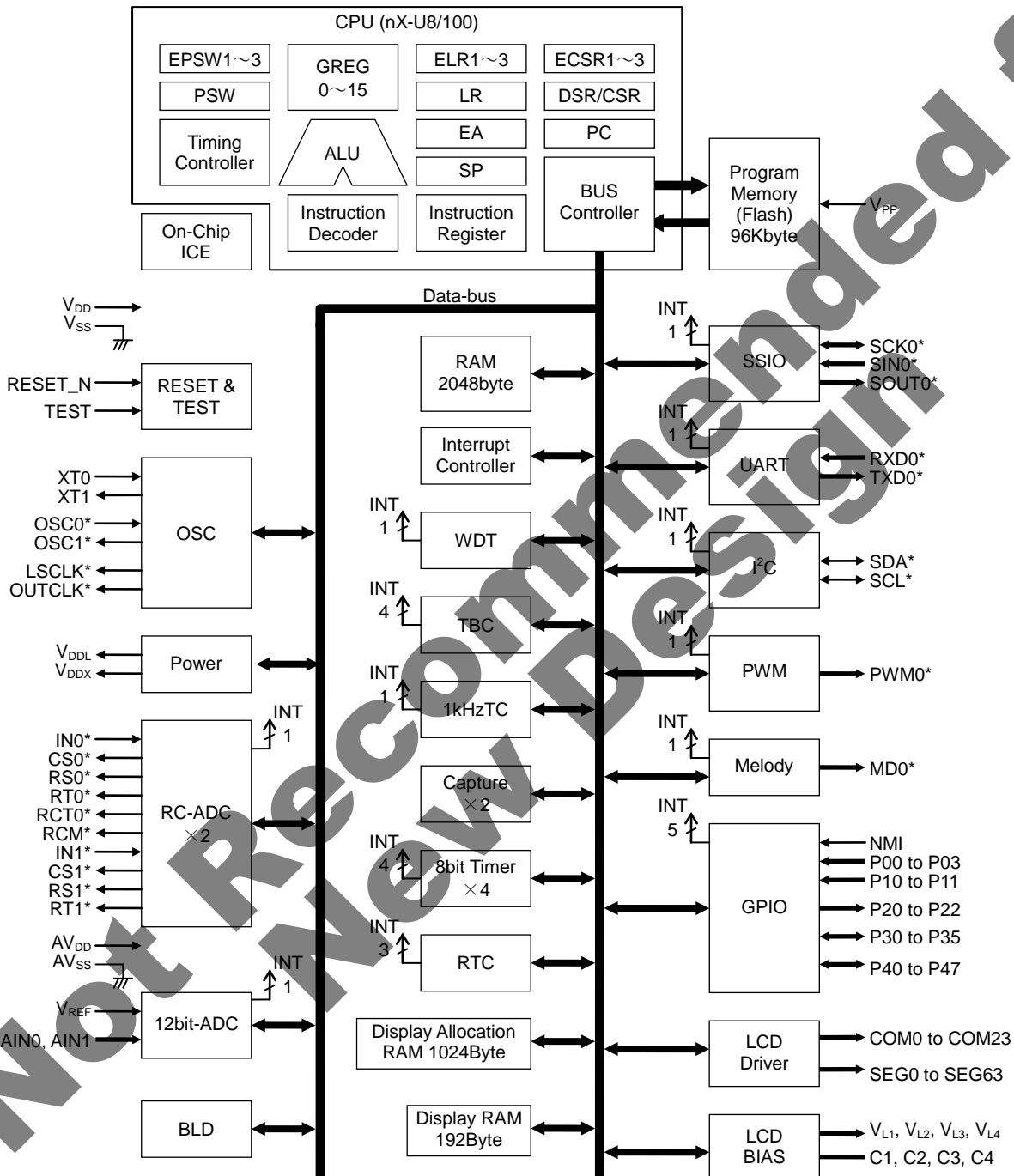

Figure 2 ML610Q436 Block Diagram



PIN CONFIGURATION

ML610Q435 LQFP144 Pin Layout

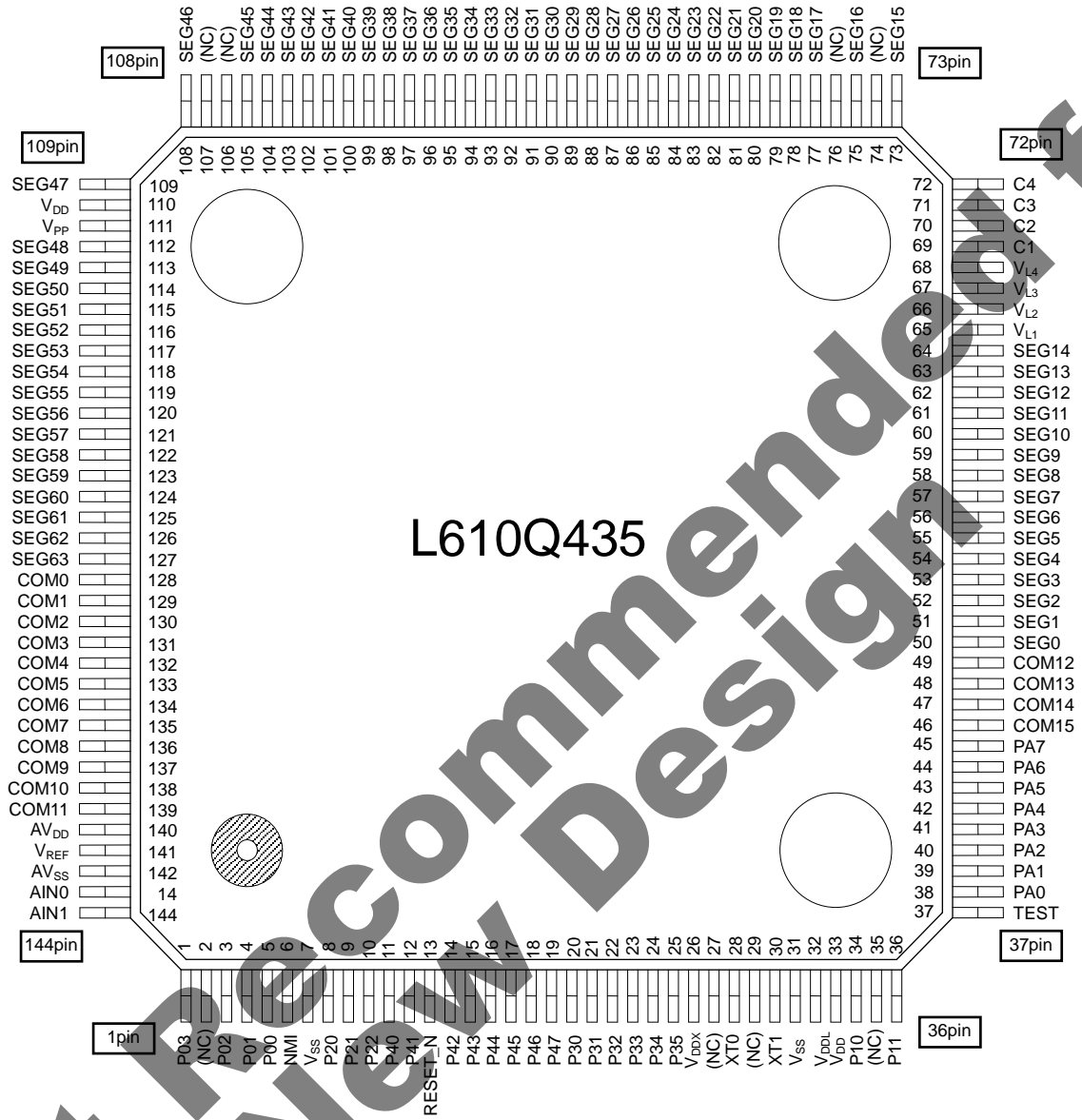
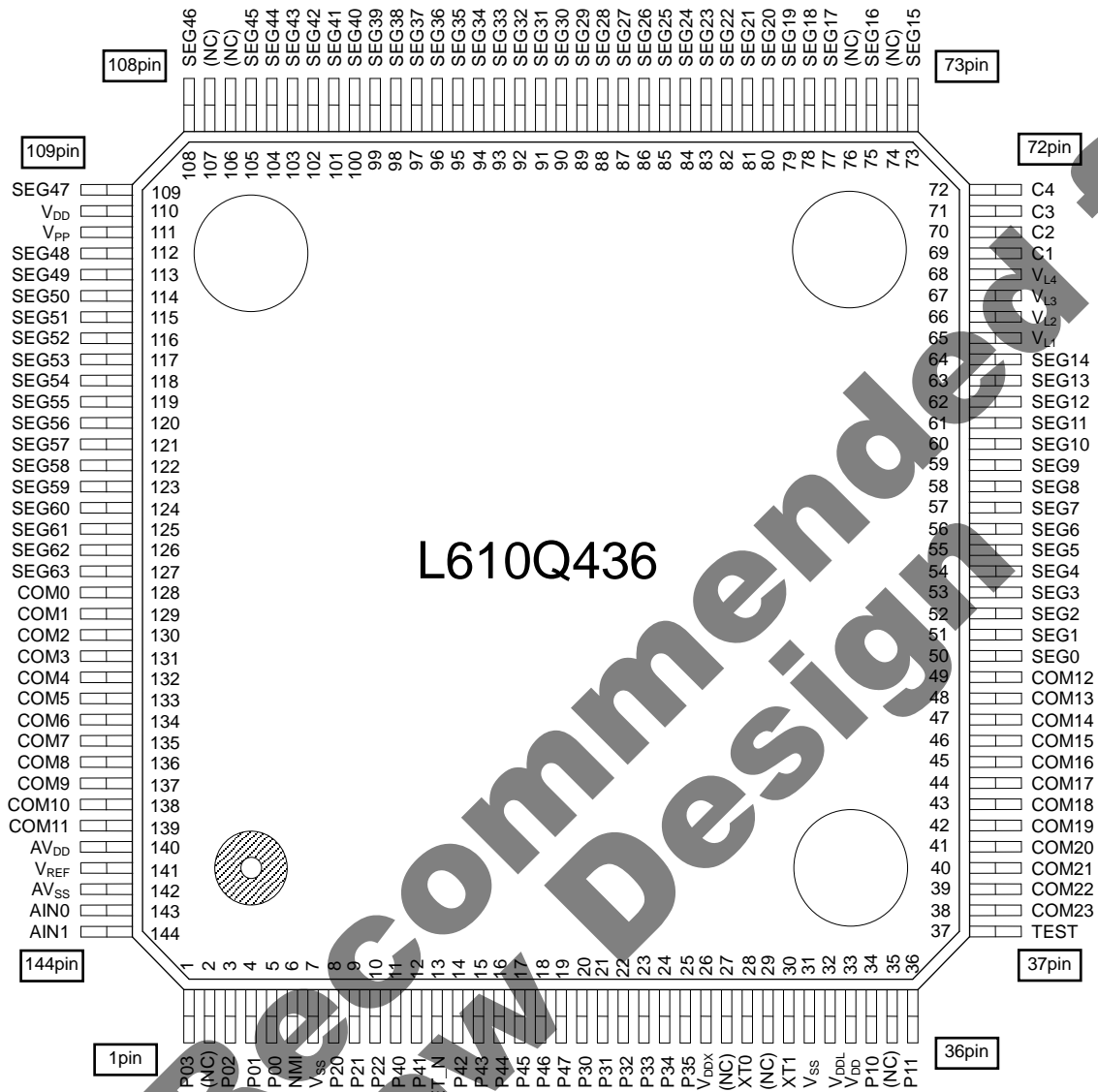

Figure 3 ML610Q435 LQFP144 Pin Configuration

ML610Q436 LQFP144 Pin Layout



(NC): No Connection

Figure 4 ML610Q436 LQFP144 Pin Configuration

ML610Q435 Chip Pin Layout & Dimension

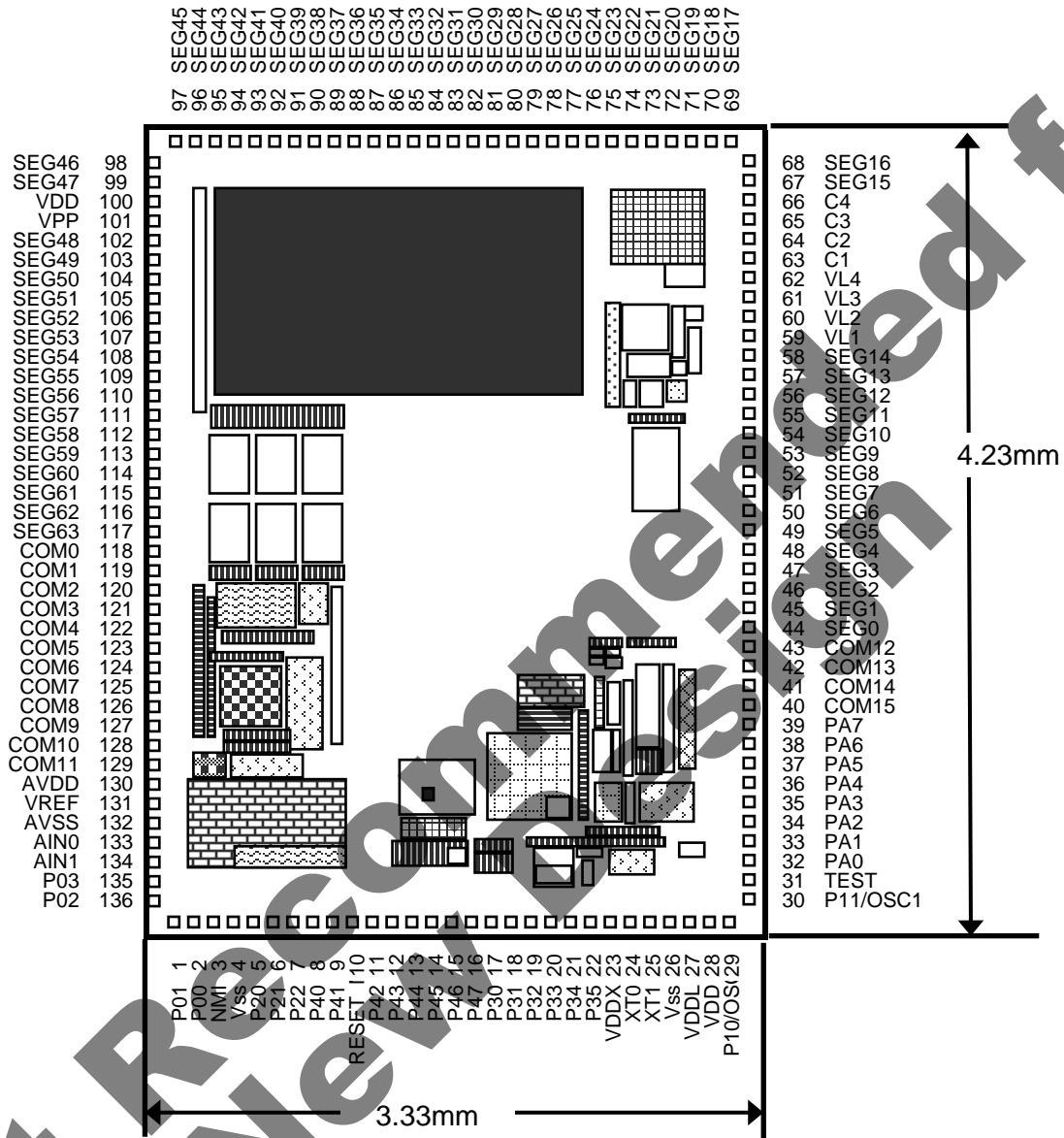

Chip size: 3.33 mm x 4.23 mm  
 PAD count: 136 pins  
 Minimum PAD pitch: 100 μm  
 PAD aperture: 80 μm x 80 μm  
 Chip thickness: 350 μm  
 Voltage of the rear side of chip: V<sub>SS</sub> level

Figure 5 ML610Q435 Chip Layout & Dimension

ML610Q436 Chip Pin Layout & Dimension

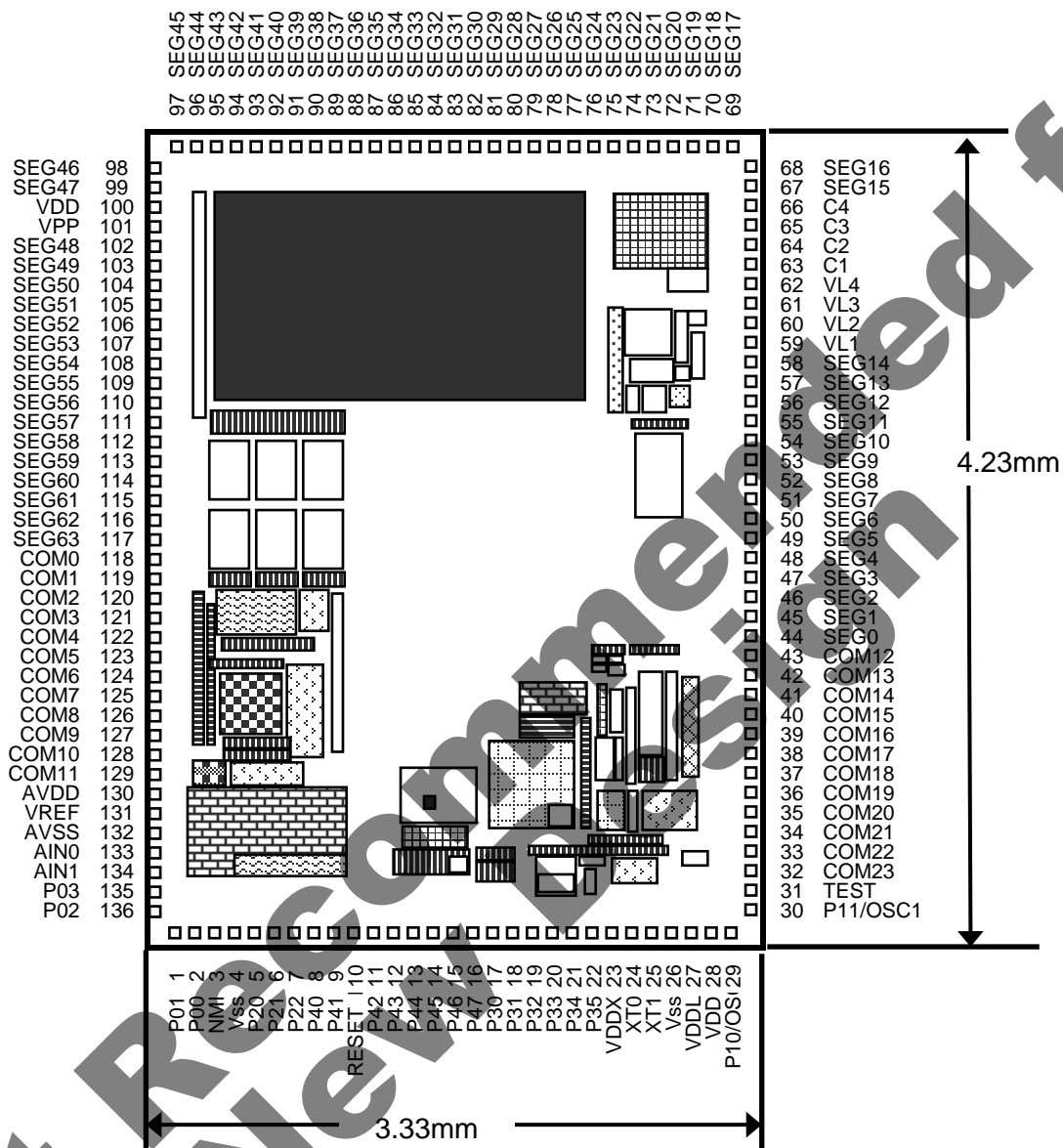

Chip size:	3.33 mm × 4.23 mm
PAD count:	136 pins
Minimum PAD pitch:	100 μm
PAD aperture:	80 μm × 80 μm
Chip thickness:	350 μm
Voltage of the rear side of chip:	V <sub>SS</sub> level

Figure 6 ML610Q436 Chip Layout & Dimension

## ML610Q435 Pad Coordinates

Table 1 ML610Q435 Pad Coordinates

Chip Center: X=0,Y=0

PAD No.	Pad Name	X (μm)	Y (μm)	PAD No.	Pad Name	X (μm)	Y (μm)	PAD No.	Pad Name	X (μm)	Y (μm)
1	P01	-1400	-1978	51	SEG7	1528	200	101	V <sub>PP</sub>	-1528	1600
2	P00	-1300	-1978	52	SEG8	1528	300	102	SEG48	-1528	1500
3	NMI	-1200	-1978	53	SEG9	1528	400	103	SEG49	-1528	1400
4	V <sub>SS</sub>	-1100	-1978	54	SEG10	1528	500	104	SEG50	-1528	1300
5	P20	-1000	-1978	55	SEG11	1528	600	105	SEG51	-1528	1200
6	P21	-900	-1978	56	SEG12	1528	700	106	SEG52	-1528	1100
7	P22	-800	-1978	57	SEG13	1528	800	107	SEG53	-1528	1000
8	P40	-700	-1978	58	SEG14	1528	900	108	SEG54	-1528	900
9	P41	-600	-1978	59	V <sub>L1</sub>	1528	1000	109	SEG55	-1528	800
10	RESET_N	-500	-1978	60	V <sub>L2</sub>	1528	1100	110	SEG56	-1528	700
11	P42	-400	-1978	61	V <sub>L3</sub>	1528	1200	111	SEG57	-1528	600
12	P43	-300	-1978	62	V <sub>L4</sub>	1528	1300	112	SEG58	-1528	500
13	P44	-200	-1978	63	C1	1528	1400	113	SEG59	-1528	400
14	P45	-100	-1978	64	C2	1528	1500	114	SEG60	-1528	300
15	P46	0	-1978	65	C3	1528	1600	115	SEG61	-1528	200
16	P47	100	-1978	66	C4	1528	1700	116	SEG62	-1528	100
17	P30	200	-1978	67	SEG15	1528	1800	117	SEG63	-1528	0
18	P31	300	-1978	68	SEG16	1528	1900	118	COM0	-1528	-100
19	P32	400	-1978	69	SEG17	1400	1978	119	COM1	-1528	-200
20	P33	500	-1978	70	SEG18	1300	1978	120	COM2	-1528	-300
21	P34	600	-1978	71	SEG19	1200	1978	121	COM3	-1528	-400
22	P35	700	-1978	72	SEG20	1100	1978	122	COM4	-1528	-500
23	V <sub>DDX</sub>	800	-1978	73	SEG21	1000	1978	123	COM5	-1528	-600
24	XT0	900	-1978	74	SEG22	900	1978	124	COM6	-1528	-700
25	XT1	1000	-1978	75	SEG23	800	1978	125	COM7	-1528	-800
26	V <sub>SS</sub>	1100	-1978	76	SEG24	700	1978	126	COM8	-1528	-900
27	V <sub>DDL</sub>	1200	-1978	77	SEG25	600	1978	127	COM9	-1528	-1000
28	V <sub>DD</sub>	1300	-1978	78	SEG26	500	1978	128	COM10	-1528	-1100
29	P10	1400	-1978	79	SEG27	400	1978	129	COM11	-1528	-1200
30	P11	1528	-1900	80	SEG28	300	1978	130	A <sub>VDD</sub>	-1528	-1300
31	TEST	1528	-1800	81	SEG29	200	1978	131	V <sub>REF</sub>	-1528	-1400
32	PA0	1528	-1700	82	SEG30	100	1978	132	A <sub>VSS</sub>	-1528	-1500
33	PA1	1528	-1600	83	SEG31	0	1978	133	AIN0	-1528	-1600
34	PA2	1528	-1500	84	SEG32	-100	1978	134	AIN1	-1528	-1700
35	PA3	1528	-1400	85	SEG33	-200	1978	135	P03	-1528	-1800
36	PA4	1528	-1300	86	SEG34	-300	1978	136	P02	-1528	-1900
37	PA5	1528	-1200	87	SEG35	-400	1978				
38	PA6	1528	-1100	88	SEG36	-500	1978				
39	PA7	1528	-1000	89	SEG37	-600	1978				
40	COM15	1528	-900	90	SEG38	-700	1978				
41	COM14	1528	-800	91	SEG39	-800	1978				
42	COM13	1528	-700	92	SEG40	-900	1978				
43	COM12	1528	-600	93	SEG41	-1000	1978				
44	SEG0	1528	-500	94	SEG42	-1100	1978				
45	SEG1	1528	-400	95	SEG43	-1200	1978				
46	SEG2	1528	-300	96	SEG44	-1300	1978				
47	SEG3	1528	-200	97	SEG45	-1400	1978				
48	SEG4	1528	-100	98	SEG46	-1528	1900				
49	SEG5	1528	0	99	SEG47	-1528	1800				
50	SEG6	1528	100	100	V <sub>DD</sub>	-1528	1700				

## ML610Q436 Pad Coordinates

Table 2 ML610Q436 Pad Coordinates

Chip Center: X=0,Y=0

PAD No.	Pad Name	X (μm)	Y (μm)	PAD No.	Pad Name	X (μm)	Y (μm)	PAD No.	Pad Name	X (μm)	Y (μm)
1	P01	-1400	-1978	51	SEG7	1528	200	101	V <sub>PP</sub>	-1528	1600
2	P00	-1300	-1978	52	SEG8	1528	300	102	SEG48	-1528	1500
3	NMI	-1200	-1978	53	SEG9	1528	400	103	SEG49	-1528	1400
4	V <sub>SS</sub>	-1100	-1978	54	SEG10	1528	500	104	SEG50	-1528	1300
5	P20	-1000	-1978	55	SEG11	1528	600	105	SEG51	-1528	1200
6	P21	-900	-1978	56	SEG12	1528	700	106	SEG52	-1528	1100
7	P22	-800	-1978	57	SEG13	1528	800	107	SEG53	-1528	1000
8	P40	-700	-1978	58	SEG14	1528	900	108	SEG54	-1528	900
9	P41	-600	-1978	59	V <sub>L1</sub>	1528	1000	109	SEG55	-1528	800
10	RESET_N	-500	-1978	60	V <sub>L2</sub>	1528	1100	110	SEG56	-1528	700
11	P42	-400	-1978	61	V <sub>L3</sub>	1528	1200	111	SEG57	-1528	600
12	P43	-300	-1978	62	V <sub>L4</sub>	1528	1300	112	SEG58	-1528	500
13	P44	-200	-1978	63	C1	1528	1400	113	SEG59	-1528	400
14	P45	-100	-1978	64	C2	1528	1500	114	SEG60	-1528	300
15	P46	0	-1978	65	C3	1528	1600	115	SEG61	-1528	200
16	P47	100	-1978	66	C4	1528	1700	116	SEG62	-1528	100
17	P30	200	-1978	67	SEG15	1528	1800	117	SEG63	-1528	0
18	P31	300	-1978	68	SEG16	1528	1900	118	COM0	-1528	-100
19	P32	400	-1978	69	SEG17	1400	1978	119	COM1	-1528	-200
20	P33	500	-1978	70	SEG18	1300	1978	120	COM2	-1528	-300
21	P34	600	-1978	71	SEG19	1200	1978	121	COM3	-1528	-400
22	P35	700	-1978	72	SEG20	1100	1978	122	COM4	-1528	-500
23	V <sub>DDX</sub>	800	-1978	73	SEG21	1000	1978	123	COM5	-1528	-600
24	XT0	900	-1978	74	SEG22	900	1978	124	COM6	-1528	-700
25	XT1	1000	-1978	75	SEG23	800	1978	125	COM7	-1528	-800
26	V <sub>SS</sub>	1100	-1978	76	SEG24	700	1978	126	COM8	-1528	-900
27	V <sub>DDL</sub>	1200	-1978	77	SEG25	600	1978	127	COM9	-1528	-1000
28	V <sub>DD</sub>	1300	-1978	78	SEG26	500	1978	128	COM10	-1528	-1100
29	P10	1400	-1978	79	SEG27	400	1978	129	COM11	-1528	-1200
30	P11	1528	-1900	80	SEG28	300	1978	130	A <sub>VDD</sub>	-1528	-1300
31	TEST	1528	-1800	81	SEG29	200	1978	131	V <sub>REF</sub>	-1528	-1400
32	COM23	1528	-1700	82	SEG30	100	1978	132	A <sub>VSS</sub>	-1528	-1500
33	COM22	1528	-1600	83	SEG31	0	1978	133	AIN0	-1528	-1600
34	COM21	1528	-1500	84	SEG32	-100	1978	134	AIN1	-1528	-1700
35	COM20	1528	-1400	85	SEG33	-200	1978	135	P03	-1528	-1800
36	COM19	1528	-1300	86	SEG34	-300	1978	136	P02	-1528	-1900
37	COM18	1528	-1200	87	SEG35	-400	1978				
38	COM17	1528	-1100	88	SEG36	-500	1978				
39	COM16	1528	-1000	89	SEG37	-600	1978				
40	COM15	1528	-900	90	SEG38	-700	1978				
41	COM14	1528	-800	91	SEG39	-800	1978				
42	COM13	1528	-700	92	SEG40	-900	1978				
43	COM12	1528	-600	93	SEG41	-1000	1978				
44	SEG0	1528	-500	94	SEG42	-1100	1978				
45	SEG1	1528	-400	95	SEG43	-1200	1978				
46	SEG2	1528	-300	96	SEG44	-1300	1978				
47	SEG3	1528	-200	97	SEG45	-1400	1978				
48	SEG4	1528	-100	98	SEG46	-1528	1900				
49	SEG5	1528	0	99	SEG47	-1528	1800				
50	SEG6	1528	100	100	V <sub>DD</sub>	-1528	1700				

## PIN LIST

PAD No.		Primary function			Secondary function			Tertiary function		
Q435	Q436	Pin name	I/O	Function	Pin name	I/O	Function	Pin name	I/O	Function
4,26	4,26	V <sub>SS</sub>	—	Negative power supply pin	—	—	—	—	—	—
28, 100	28, 100	V <sub>DD</sub>	—	Positive power supply pin	—	—	—	—	—	—
27	27	V <sub>DDL</sub>	—	Power supply pin for internal logic (internally generated)	—	—	—	—	—	—
23	23	V <sub>DDX</sub>	—	Power supply pin for low-speed oscillation (internally generated)	—	—	—	—	—	—
101	101	V <sub>PP</sub>	—	Power supply pin for Flash ROM	—	—	—	—	—	—
132	132	AV <sub>SS</sub>	—	Negative power supply pin for successive approximation type ADC	—	—	—	—	—	—
130	130	AV <sub>DD</sub>	—	Positive power supply pin for successive approximation type ADC	—	—	—	—	—	—
59	59	V <sub>L1</sub>	—	Power supply pin for LCD bias (internally generated)	—	—	—	—	—	—
60	60	V <sub>L2</sub>	—	Power supply pin for LCD bias (internally generated)	—	—	—	—	—	—
61	61	V <sub>L3</sub>	—	Power supply pin for LCD bias (internally generated)	—	—	—	—	—	—
62	62	V <sub>L4</sub>	—	Power supply pin for LCD bias (internally generated)	—	—	—	—	—	—
63	63	C1	—	Capacitor connection pin for LCD bias generation	—	—	—	—	—	—
64	64	C2	—	Capacitor connection pin for LCD bias generation	—	—	—	—	—	—
65	65	C3	—	Capacitor connection pin for LCD bias generation	—	—	—	—	—	—
66	66	C4	—	Capacitor connection pin for LCD bias generation	—	—	—	—	—	—
31	31	TEST	I/O	Input/output pin for testing	—	—	—	—	—	—
10	10	RESET <sub>N</sub>	I	Reset input pin	—	—	—	—	—	—
24	24	XT0	I	Low-speed clock oscillation pin	—	—	—	—	—	—
25	25	XT1	O	Low-speed clock oscillation pin	—	—	—	—	—	—
131	131	V <sub>REF</sub>	—	Reference power supply pin for successive approximation type ADC	—	—	—	—	—	—

PAD No.		Primary function			Secondary function			Tertiary function		
Q435	Q436	Pin name	I/O	Function	Pin name	I/O	Function	Pin name	I/O	Function
133	133	AIN0	I	Successive approximation type ADC input	—	—	—	—	—	—
134	134	AIN1	I	Successive approximation type ADC input	—	—	—	—	—	—
3	3	NMI	I	Non-maskable interrupt pin	—	—	—	—	—	—
2	2	P00/EXI0/CAP0	I	Input port, External interrupt 0, Capture 0 input	—	—	—	—	—	—
1	1	P01/EXI1/CAP1	I	Input port, External interrupt 1, Capture 1 input	—	—	—	—	—	—
136	136	P02/EXI2/RXD0	I	Input port, External interrupt 2, UART0 receive	—	—	—	—	—	—
135	135	P03/EXI3	I	Input port, External interrupt 3	—	—	—	—	—	—
29	29	P10	I	Input port	OSC0	I	High-speed oscillation	—	—	—
30	30	P11	I	Input port	OSC1	O	High-speed oscillation	—	—	—
5	5	P20/LED0	O	Output port	LSCLK	O	Low-speed clock output	—	—	—
6	6	P21/LED1	O	Output port	OUTCLK	O	High-speed clock output	—	—	—
7	7	P22/LED2	O	Output port	MD0	O	Melody output	—	—	—
17	17	P30	I/O	Input/output port	IN0	I	RC type ADC0 oscillation input pin	—	—	—
18	18	P31	I/O	Input/output port	CS0	O	RC type ADC0 reference capacitor connection pin	—	—	—
19	19	P32	I/O	Input/output port	RS0	O	RC type ADC0 reference resistor connection pin	—	—	—
20	20	P33	I/O	Input/output port	RT0	O	RC type ADC0 resistor sensor connection pin	—	—	—
21	21	P34	I/O	Input/output port	RCT0	O	RC type ADC0 resistor/capacitor sensor connection pin	PWM0	O	PWM output
22	22	P35	I/O	Input/output port	RCM	O	RC type ADC oscillation monitor	—	—	—
8	8	P40	I/O	Input/output port	SDA	I/O	I <sup>2</sup> C data input/output	SIN0	I	SSIO data input
9	9	P41	I/O	Input/output port	SCL	I/O	I <sup>2</sup> C clock input/output	SCK0	I/O	SSIO synchronous clock
11	11	P42	I/O	Input/output port	RXD0	I	UART data input	SOUT0	O	SSIO data output
12	12	P43	I/O	Input/output port	TXD0	O	UART data output	PWM0	O	PWM output
13	13	P44/T02/P0CK	I/O	Input/output port, Timer 0/Timer 2/PWM0 external clock input	IN1	I	RC type ADC1 oscillation input pin	SIN0	I	SSIO0 data input
14	14	P45/T13/P1CK	I/O	Input/output port, Timer 1/Timer 3 external clock input	CS1	O	RC type ADC1 reference capacitor connection pin	SCK0	I/O	SSIO0 synchronous clock
15	15	P46	I/O	Input/output port	RS1	O	RC type ADC1 reference resistor connection pin	SOUT0	O	SSIO0 data output
16	16	P47	I/O	Input/output port	RT1	O	RC type ADC1 resistor sensor connection pin	—	—	—
—	32	PA0	I/O	Input/output port	—	—	—	—	—	—
—	33	PA1	I/O	Input/output port	—	—	—	—	—	—
—	34	PA2	I/O	Input/output port	—	—	—	—	—	—
—	35	PA3	I/O	Input/output port	—	—	—	—	—	—
—	36	PA4	I/O	Input/output port	—	—	—	—	—	—
—	37	PA5	I/O	Input/output port	—	—	—	—	—	—



PAD No.		Primary function			Secondary function			Tertiary function		
Q435	Q436	Pin name	I/O	Function	Pin name	I/O	Function	Pin name	I/O	Function
—	38	PA6	I/O	Input/output port	—	—	—	—	—	—
—	39	PA7	I/O	Input/output port	—	—	—	—	—	—
118	118	COM0	O	LCD common pin	—	—	—	—	—	—
119	119	COM1	O	LCD common pin	—	—	—	—	—	—
120	120	COM2	O	LCD common pin	—	—	—	—	—	—
121	121	COM3	O	LCD common pin	—	—	—	—	—	—
122	122	COM4	O	LCD common pin	—	—	—	—	—	—
123	123	COM5	O	LCD common pin	—	—	—	—	—	—
124	124	COM6	O	LCD common pin	—	—	—	—	—	—
125	125	COM7	O	LCD common pin	—	—	—	—	—	—
126	126	COM8	O	LCD common pin	—	—	—	—	—	—
127	127	COM9	O	LCD common pin	—	—	—	—	—	—
128	128	COM10	O	LCD common pin	—	—	—	—	—	—
129	129	COM11	O	LCD common pin	—	—	—	—	—	—
43	43	COM12	O	LCD common pin	—	—	—	—	—	—
42	42	COM13	O	LCD common pin	—	—	—	—	—	—
41	41	COM14	O	LCD common pin	—	—	—	—	—	—
40	40	COM15	O	LCD common pin	—	—	—	—	—	—
39	—	COM16	O	LCD common pin	—	—	—	—	—	—
38	—	COM17	O	LCD common pin	—	—	—	—	—	—
37	—	COM18	O	LCD common pin	—	—	—	—	—	—
36	—	COM19	O	LCD common pin	—	—	—	—	—	—
35	—	COM20	O	LCD common pin	—	—	—	—	—	—
34	—	COM21	O	LCD common pin	—	—	—	—	—	—
33	—	COM22	O	LCD common pin	—	—	—	—	—	—
32	—	COM23	O	LCD common pin	—	—	—	—	—	—
44	44	SEG0	O	LCD segment pin	—	—	—	—	—	—
45	45	SEG1	O	LCD segment pin	—	—	—	—	—	—
46	46	SEG2	O	LCD segment pin	—	—	—	—	—	—
47	47	SEG3	O	LCD segment pin	—	—	—	—	—	—
48	48	SEG4	O	LCD segment pin	—	—	—	—	—	—
49	49	SEG5	O	LCD segment pin	—	—	—	—	—	—
50	50	SEG6	O	LCD segment pin	—	—	—	—	—	—
51	51	SEG7	O	LCD segment pin	—	—	—	—	—	—
52	52	SEG8	O	LCD segment pin	—	—	—	—	—	—
53	53	SEG9	O	LCD segment pin	—	—	—	—	—	—
54	54	SEG10	O	LCD segment pin	—	—	—	—	—	—
55	55	SEG11	O	LCD segment pin	—	—	—	—	—	—
56	56	SEG12	O	LCD segment pin	—	—	—	—	—	—
57	57	SEG13	O	LCD segment pin	—	—	—	—	—	—
58	58	SEG14	O	LCD segment pin	—	—	—	—	—	—
67	67	SEG15	O	LCD segment pin	—	—	—	—	—	—
68	68	SEG16	O	LCD segment pin	—	—	—	—	—	—
69	69	SEG17	O	LCD segment pin	—	—	—	—	—	—
70	70	SEG18	O	LCD segment pin	—	—	—	—	—	—
71	71	SEG19	O	LCD segment pin	—	—	—	—	—	—
72	72	SEG20	O	LCD segment pin	—	—	—	—	—	—
73	73	SEG21	O	LCD segment pin	—	—	—	—	—	—
74	74	SEG22	O	LCD segment pin	—	—	—	—	—	—
75	75	SEG23	O	LCD segment pin	—	—	—	—	—	—
76	76	SEG24	O	LCD segment pin	—	—	—	—	—	—
77	77	SEG25	O	LCD segment pin	—	—	—	—	—	—
78	78	SEG26	O	LCD segment pin	—	—	—	—	—	—

PAD No.		Primary function			Secondary function			Tertiary function		
Q435	Q436	Pin name	I/O	Function	Pin name	I/O	Function	Pin name	I/O	Function
79	79	SEG27	O	LCD segment pin	—	—	—	—	—	—
80	80	SEG28	O	LCD segment pin	—	—	—	—	—	—
81	81	SEG29	O	LCD segment pin	—	—	—	—	—	—
82	82	SEG30	O	LCD segment pin	—	—	—	—	—	—
83	83	SEG31	O	LCD segment pin	—	—	—	—	—	—
84	84	SEG32	O	LCD segment pin	—	—	—	—	—	—
85	85	SEG33	O	LCD segment pin	—	—	—	—	—	—
86	86	SEG34	O	LCD segment pin	—	—	—	—	—	—
87	87	SEG35	O	LCD segment pin	—	—	—	—	—	—
88	88	SEG36	O	LCD segment pin	—	—	—	—	—	—
89	89	SEG37	O	LCD segment pin	—	—	—	—	—	—
90	90	SEG38	O	LCD segment pin	—	—	—	—	—	—
91	91	SEG39	O	LCD segment pin	—	—	—	—	—	—
92	92	SEG40	O	LCD segment pin	—	—	—	—	—	—
93	93	SEG41	O	LCD segment pin	—	—	—	—	—	—
94	94	SEG42	O	LCD segment pin	—	—	—	—	—	—
95	95	SEG43	O	LCD segment pin	—	—	—	—	—	—
96	96	SEG44	O	LCD segment pin	—	—	—	—	—	—
97	97	SEG45	O	LCD segment pin	—	—	—	—	—	—
98	98	SEG46	O	LCD segment pin	—	—	—	—	—	—
99	99	SEG47	O	LCD segment pin	—	—	—	—	—	—
102	102	SEG48	O	LCD segment pin	—	—	—	—	—	—
103	103	SEG49	O	LCD segment pin	—	—	—	—	—	—
104	104	SEG50	O	LCD segment pin	—	—	—	—	—	—
105	105	SEG51	O	LCD segment pin	—	—	—	—	—	—
106	106	SEG52	O	LCD segment pin	—	—	—	—	—	—
107	107	SEG53	O	LCD segment pin	—	—	—	—	—	—
108	108	SEG54	O	LCD segment pin	—	—	—	—	—	—
109	109	SEG55	O	LCD segment pin	—	—	—	—	—	—
110	110	SEG56	O	LCD segment pin	—	—	—	—	—	—
111	111	SEG57	O	LCD segment pin	—	—	—	—	—	—
112	112	SEG58	O	LCD segment pin	—	—	—	—	—	—
113	113	SEG59	O	LCD segment pin	—	—	—	—	—	—
114	114	SEG60	O	LCD segment pin	—	—	—	—	—	—
115	115	SEG61	O	LCD segment pin	—	—	—	—	—	—
116	116	SEG62	O	LCD segment pin	—	—	—	—	—	—
117	117	SEG63	O	LCD segment pin	—	—	—	—	—	—

## PIN DESCRIPTION

Pin name	I/O	Description	Primary/ Secondary/ Tertiary	Logic
System				
RESET_N	I	Reset input pin. When this pin is set to a "L" level, system reset mode is set and the internal section is initialized. When this pin is set to a "H" level subsequently, program execution starts. A pull-up resistor is internally connected.	—	Negative
XT0	I	Crystal connection pin for low-speed clock.	—	—
XT1	O	A 32.768 kHz crystal oscillator (see measuring circuit 1) is connected to this pin. Capacitors CDL and CGL are connected across this pin and V <sub>SS</sub> as required.	—	—
OSC0	I	Crystal/ceramic connection pin for high-speed clock.	Secondary	—
OSC1	O	A crystal or ceramic is connected to this pin (4.1 MHz max.). Capacitors CDH and CGH (see measuring circuit 1) are connected across this pin and V <sub>SS</sub> . This pin is used as the secondary function of the P10 pin(OSC0) and P11 pin(OSC1).	Secondary	—
LSCLK	O	Low-speed clock output pin. This pin is used as the secondary function of the P20 pin.	Secondary	—
OUTCLK	O	High-speed clock output pin. This pin is used as the secondary function of the P21 pin.	Secondary	—
General-purpose input port				
P00-P03	I	General-purpose input port. Since these pins have secondary functions, the pins cannot be used as a port when the secondary functions are used.	Primary	Positive
P10-P11	I	General-purpose input port. Since these pins have secondary functions, the pins cannot be used as a port when the secondary functions are used.	Primary	Positive
General-purpose output port				
P20-P22	O	General-purpose output port. Since these pins have secondary functions, the pins cannot be used as a port when the secondary functions are used.	Primary	Positive
General-purpose input/output port				
P30-P35	I/O	General-purpose input/output port. Since these pins have secondary functions, the pins cannot be used as a port when the secondary functions are used.	Primary	Positive
P40-P47	I/O	General-purpose input/output port. Since these pins have secondary functions, the pins cannot be used as a port when the secondary functions are used.	Primary	Positive
PA0-PA7	I/O	General-purpose input/output port. These pins are for the ML610Q435, but are not provided in the ML610Q436.	Primary	Positive

Pin name	I/O	Description	Primary/ Secondary/ Tertiary	Logic
<b>UART</b>				
TXD0	O	UART data output pin. This pin is used as the secondary function of the P43 pin.	Secondary	Positive
RXD0	I	UART data input pin. This pin is used as the secondary function of the P42 or the primary function of the P02 pin.	Primary/Secondary	Positive
<b>I<sup>2</sup>C bus interface</b>				
SDA	I/O	I <sup>2</sup> C data input/output pin. This pin is used as the secondary function of the P40 pin. This pin has an NMOS open drain output. When using this pin as a function of the I <sup>2</sup> C, externally connect a pull-up resistor.	Secondary	Positive
SCL	O	I <sup>2</sup> C clock output pin. This pin is used as the secondary function of the P41 pin. This pin has an NMOS open drain output. When using this pin as a function of the I <sup>2</sup> C, externally connect a pull-up resistor.	Secondary	Positive
<b>Synchronous serial (SSIO)</b>				
SCK0	I/O	Synchronous serial clock input/output pin. This pin is used as the tertiary function of the P41 or P45 pin.	Tertiary	—
SIN0	I	Synchronous serial data input pin. This pin is used as the tertiary function of the P40 or P44 pin.	Tertiary	Positive
SOUT0	O	Synchronous serial data output pin. This pin is used as the tertiary function of the P42 or P46 pin.	Tertiary	Positive
<b>PWM</b>				
PWM0	O	PWM0 output pin. This pin is used as the tertiary function of the P43 or P34 pin.	Tertiary	Positive
T02P0CK	I	PWM0 external clock input pin. This pin is used as the primary function of the P44 pin.	Primary	—
<b>External interrupt</b>				
NMI	I	External non-maskable interrupt input pin. An interrupt is generated on both edges.	Primary	Positive/negative
EXI0-3	I	External maskable interrupt input pins. Interrupt enable and edge selection can be performed for each bit by software. These pins are used as the primary functions of the P00-P03 pins.	Primary	Positive/negative
<b>Capture</b>				
CAP0	I	Capture trigger input pins. The value of the time base counter is captured in the register synchronously with the interrupt edge selected by software.	Primary	Positive/negative
CAP1	I	These pins are used as the primary functions of the P00 pin(CAP0) and P01 pin(CAP1).	Primary	Positive/negative
<b>Timer</b>				
T02P0CK	I	External clock input pin used for both Timer 0 and Timer 2. The clocks for these timers are selected by software. This pin is used as the primary function of the P44 pin.	Primary	—
T13P1CK	I	External clock input pin used for both Timer 1 and Timer 3. The clocks for these timers are selected by software. This pin is used as the primary function of the P45 pin.	Primary	—
<b>Melody</b>				
MD0	O	Melody/buzzer signal output pin. This pin is used as the secondary function of the P22 pin.	Secondary	Positive/negative
<b>LED drive</b>				
LED0-2	O	NMOS open drain output pins to drive LED. These pins are used as the primary function of the P20-P22 pins.	Primary	Positive/negative

Pin name	I/O	Description	Primary/ Secondary/ Tertiary	Logic
<b>RC oscillation type A/D converter</b>				
IN0	I	Channel 0 oscillation input pin. This pin is used as the secondary function of the P30 pin.	Secondary	—
CS0	O	Channel 0 reference capacitor connection pin. This pin is used as the secondary function of the P31 pin.	Secondary	—
RS0	O	This pin is used as the secondary function of the P32 pin which is the reference resistor connection pin of Channel 0.	Secondary	—
RT0	O	Resistor sensor connection pin of Channel 0 for measurement. This pin is used as the secondary function of the P34 pin.	Secondary	—
RCT0	O	Resistor/capacitor sensor connection pin of Channel 0 for measurement. This pin is used as the secondary function of the P33 pin.	Secondary	—
RCM	O	RC oscillation monitor pin. This pin is used as the secondary function of the P35 pin.	Secondary	—
IN1	I	Oscillation input pin of Channel 1. This pin is used as the secondary function of the P44 pin.	Secondary	—
CS1	O	Reference capacitor connection pin of Channel 1. This pin is used as the secondary function of the P45 pin.	Secondary	—
RS1	O	Reference resistor connection pin of Channel 1. This pin is used as the secondary function of the P46 pin.	Secondary	—
RT1	O	Resistor sensor connection pin for measurement of Channel 1. This pin is used as the secondary function of the P47 pin.	Secondary	—
<b>Successive approximation type A/D converter</b>				
AV <sub>SS</sub>	—	Negative power supply pin for successive approximation type A/D converter.	—	—
AV <sub>DD</sub>	—	Positive power supply pin for successive approximation type A/D converter.	—	—
V <sub>REF</sub>	—	Reference power supply pin for successive approximation type A/D converter.	—	—
AIN0	I	Channel 0 analog input for successive approximation type A/D converter.	—	—
AIN1	I	Channel 1 analog input for successive approximation type A/D converter.	—	—
<b>LCD drive signal</b>				
COM0-15	O	Common output pins.	—	—
COM16-23	O	Common output pins. These pins are for the ML610Q436, but are not provided in the ML610Q435.	—	—
SEG0-63	O	Segment output pin.	—	—
<b>LCD driver power supply</b>				
V <sub>L1</sub>	—	Power supply pins for LCD bias (internally generated). Capacitors Ca, Cb, Cc, and Cd (see measuring circuit 1) are connected between V <sub>SS</sub> and V <sub>L1</sub> , V <sub>L2</sub> , V <sub>L3</sub> , and V <sub>L4</sub> , respectively.	—	—
V <sub>L2</sub>	—		—	—
V <sub>L3</sub>	—		—	—
V <sub>L4</sub>	—		—	—
C1	—	Power supply pins for LCD bias (internally generated). Capacitors C12 and C34 (see measuring circuit 1) are connected between C1 and C2 and between C3 and C4, respectively.	—	—
C2	—		—	—
C3	—		—	—
C4	—		—	—
<b>For testing</b>				
TEST	I/O	Input/output pin for testing. A pull-down resistor is internally connected.	—	—
<b>Power supply</b>				
V <sub>SS</sub>	—	Negative power supply pin.	—	—
V <sub>DD</sub>	—	Positive power supply pin.	—	—
V <sub>DDL</sub>	—	Positive power supply pin (internally generated) for internal logic. Capacitors CL0 and CL1 (see measuring circuit 1) are connected between this pin and V <sub>SS</sub> .	—	—
V <sub>DDX</sub>	—	Plus-side power supply pin (internally generated) for low-speed oscillation. Capacitor Cx (see measuring circuit 1) is connected between this pin and V <sub>SS</sub> .	—	—
V <sub>PP</sub>	—	Power supply pin for programming Flash ROM. A pull-up resistor is internally connected.	—	—

**TERMINATION OF UNUSED PINS**

Table 3 shows methods of terminating the unused pins.

**Table 3 Termination of Unused Pins**

Pin	Recommended pin termination
V <sub>PP</sub>	Open
AV <sub>DD</sub>	V <sub>SS</sub>
AV <sub>SS</sub>	V <sub>SS</sub>
V <sub>REF</sub>	V <sub>SS</sub>
AIN0, AIN1	Open
V <sub>L1</sub> , V <sub>L2</sub> , V <sub>L3</sub> , V <sub>L4</sub>	Open
C1, C2, C3, C4	Open
RESET_N	Open
TEST	Open
NMI	Open
P00 to P03	V <sub>DD</sub> or V <sub>SS</sub>
P10 to P11	V <sub>DD</sub>
P20 to P22	Open
P30 to P35	Open
P40 to P47	Open
PA0 to PA7	Open
COM0 to 23	Open
SEG0 to 63	Open

**Note:**

It is recommended to set the unused input ports and input/output ports to the inputs with pull-down resistors/pull-up resistors or the output mode since the supply current may become excessively large if the pins are left open in the high impedance input setting.

## ELECTRICAL CHARACTERISTICS

## ABSOLUTE MAXIMUM RATINGS

(V<sub>SS</sub> = AV<sub>SS</sub> = 0V)

Parameter	Symbol	Condition	Rating	Unit
Power supply voltage 1	V <sub>DD</sub>	Ta = 25°C	-0.3 to +4.6	V
Power supply voltage 2	AV <sub>DD</sub>	Ta = 25°C	-0.3 to +4.6	V
Power supply voltage 3	V <sub>PP</sub>	Ta = 25°C	-0.3 to +9.5	V
Power supply voltage 4	V <sub>DDL</sub>	Ta = 25°C	-0.3 to +3.6	V
Power supply voltage 5	V <sub>DDX</sub>	Ta = 25°C	-0.3 to +3.6	V
Power supply voltage 6	V <sub>L1</sub>	Ta = 25°C	-0.3 to +1.75	V
Power supply voltage 7	V <sub>L2</sub>	Ta = 25°C	-0.3 to +3.5	V
Power supply voltage 8	V <sub>L3</sub>	Ta = 25°C	-0.3 to +5.25	V
Power supply voltage 9	V <sub>L4</sub>	Ta = 25°C	-0.3 to +7.0	V
Input voltage	V <sub>IN</sub>	Ta = 25°C	-0.3 to V <sub>DD</sub> +0.3	V
Output voltage	V <sub>OUT</sub>	Ta = 25°C	-0.3 to V <sub>DD</sub> +0.3	V
Output current 1	I <sub>OUT1</sub>	Port3-A, Ta = 25°C	-12 to +11	mA
Output current 2	I <sub>OUT2</sub>	Port2, Ta = 25°C	-12 to +20	mA
Power dissipation	PD	Ta = 25°C	122	mW
Storage temperature	T <sub>STG</sub>	—	-55 to +150	°C

## RECOMMENDED OPERATING CONDITIONS

(V<sub>SS</sub> = AV<sub>SS</sub> = 0V)

Parameter	Symbol	Condition	Range	Unit
Operating temperature	T <sub>OP</sub>	—	-20 to +70	°C
Operating voltage	V <sub>DD</sub>	—	1.1 to 3.6	V
	AV <sub>DD</sub>	—	2.2 to 3.6	
Operating frequency (CPU)	f <sub>OP</sub>	V <sub>DD</sub> = 1.1 to 3.6V	30k to 36k	Hz
		V <sub>DD</sub> = 1.3 to 3.6V	30k to 650k	
		V <sub>DD</sub> = 1.8 to 3.6V	30k to 4.2M	
Capacitor externally connected to V <sub>DDL</sub> pin	C <sub>L0</sub>	—	1.0±30%	μF
	C <sub>L1</sub>	—	0.1±30%	
Capacitor externally connected to V <sub>DDX</sub> pin	C <sub>X</sub>	—	0.1±30%	μF
Capacitors externally connected to V <sub>L1, 2, 3, 4</sub> pins	C <sub>a, b, c, d</sub>	—	1.0±30%	μF
Capacitors externally connected across C1 and C2 pins and across C3 and C4 pins	C <sub>12, C34</sub>	—	1.0±30%	μF

## CLOCK GENERATION CIRCUIT OPERATING CONDITIONS

(V<sub>SS</sub> = 0V)

Parameter	Symbol	Condition	Rating			Unit
			Min.	Typ.	Max.	
Low-speed crystal oscillation frequency	f <sub>XTL</sub>	—	—	32.768k	—	Hz
Recommended equivalent series resistance value of low-speed crystal oscillation	R <sub>L</sub>	—	—	—	40k	Ω
Low-speed crystal oscillation external capacitor *1	C <sub>DL</sub> /C <sub>GL</sub>	C <sub>L</sub> =6pF of crystal oscillation *2	—	0	—	pF
		C <sub>L</sub> =9pF of crystal oscillation	—	6	—	
		C <sub>L</sub> =12pF of crystal oscillation	—	12	—	
High-speed crystal/ceramic oscillation frequency	f <sub>XTH</sub>	—	—	4.0M / 4.096M	—	Hz
High-speed crystal oscillation external capacitor	C <sub>DH</sub>	—	—	24	—	pF
	C <sub>GH</sub>	—	—	24	—	

\*1: The external C<sub>DL</sub> and C<sub>GL</sub> need to be adjusted in consideration of variation of internal loading capacitance C<sub>D</sub> and C<sub>G</sub>, and other additional capacitance such as PCB layout.

\*2: When using a crystal oscillator C<sub>L</sub> = 6pF, there is a possibility that can not be adjusted by external C<sub>DL</sub> and C<sub>GL</sub>.

Not Recommended for New Design



**OPERATING CONDITIONS OF FLASH ROM**

(V<sub>SS</sub> = AV<sub>SS</sub> = 0V)

Parameter	Symbol	Condition	Range	Unit
Operating temperature	T <sub>OP</sub>	At write/erase <sup>*1</sup>	0 to +40	°C
Operating voltage	V <sub>DD</sub>	At write/erase <sup>*1</sup>	2.75 to 3.6	V
	V <sub>DDL</sub>	At write/erase <sup>*1</sup>	2.5 to 2.75	
	V <sub>PP</sub>	At write/erase <sup>*1</sup>	7.7 to 8.3	
Write cycles	C <sub>EP</sub>	—	80	cycles
Data retention	Y <sub>DR</sub>	—	10	years

\*1: In addition the power supply to VDD pin and VPP pin, within the range 2.5V to 2.75V has to be supplied to VDDL pin when programming and erasing Flash ROM

**DC CHARACTERISTICS (1/5)**

(V<sub>DD</sub> = 1.1 to 3.6V, AV<sub>DD</sub> = 2.2 to 3.6V, V<sub>SS</sub> = AV<sub>SS</sub> = 0V, Ta = -20 to +70°C, unless otherwise specified) (1/5)

Parameter	Symbol	Condition	Rating			Unit	Measuring circuit
			Min.	Typ.	Max.		
500kHz RC oscillation frequency	f <sub>RC</sub>	V <sub>DD</sub> = 1.3 to 3.6V	Ta = 25°C	Typ. -10%	500	Typ. +10%	kHz
			Ta = -20 to +70°C	Typ. -25%	500	Typ. +25%	
PLL oscillation frequency*4	f <sub>PLL</sub>	LSCLK = 32.768kHz V <sub>DD</sub> = 1.8 to 3.6V	-2.5%	8.192	+2.5%	MHz	1
Low-speed crystal oscillation start time*2	T <sub>XTL</sub>	—	—	0.3	2	s	
500kHz RC oscillation start time	T <sub>RC</sub>	—	—	50	500	µs	
High-speed crystal oscillation start time*3	T <sub>XTH</sub>	V <sub>DD</sub> = 1.8 to 3.6V	—	2	20	ms	
PLL oscillation start time	T <sub>PLL</sub>	V <sub>DD</sub> = 1.8 to 3.6V	—	1	10		
Low-speed oscillation stop detect time*1	T <sub>STOP</sub>	—	0.2	3	20	µs	
Reset pulse width	P <sub>RST</sub>	—	200	—	—		
Reset noise elimination pulse width	P <sub>NRST</sub>	—	—	—	0.3	ms	
Power-on reset activation power rise time	T <sub>POR</sub>	—	—	—	10		

\*1: When low-speed crystal oscillation stops for a duration more than the low-speed oscillation stop detect time, the system is reset to shift to system reset mode. "A" version (ML610Q435A/Q436A) don't have this spec.

\*2: Use 32.768KHz Crystal Oscillator C-001R (Epson Toyocom) with capacitance C<sub>GL</sub>/C<sub>DL</sub> = 0pF.

\*3: Use 4.096MHz Crystal Oscillator HC49SFWB (Kyocera).

\*4: 1024 clock average.

[Reset pulse width]

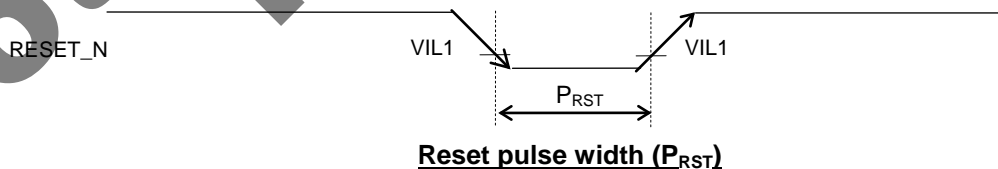

[Power-on reset activation power rise time]

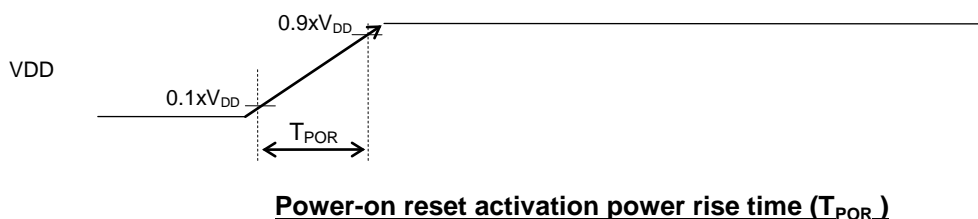

## DC CHARACTERISTICS (2/5)

(V<sub>DD</sub> = 1.1 to 3.6V, AV<sub>DD</sub> = 2.2 to 3.6V, V<sub>SS</sub> = AV<sub>SS</sub> = 0V, Ta = -20 to +70°C, unless otherwise specified) (2/5)

Parameter	Symbol	Condition	Rating			Unit	Measuring circuit	
			Min.	Typ.	Max.			
V <sub>L1</sub> voltage	V <sub>L1</sub>	V <sub>DD</sub> = 3.0V, T <sub>j</sub> = 25°C	CN4-0 = 00H	0.89	0.94	0.99	V	1
			CN4-0 = 01H	0.91	0.96	1.01		
			CN4-0 = 02H	0.93	0.98	1.03		
			CN4-0 = 03H	0.95	1.00	1.05		
			CN4-0 = 04H	0.97	1.02	1.07		
			CN4-0 = 05H	0.99	1.04	1.09		
			CN4-0 = 06H	1.01	1.06	1.11		
			CN4-0 = 07H	1.03	1.08	1.13		
			CN4-0 = 08H	1.05	1.10	1.15		
			CN4-0 = 09H	1.07	1.12	1.17		
			CN4-0 = 0AH	1.09	1.14	1.19		
			CN4-0 = 0BH	1.11	1.16	1.21		
			CN4-0 = 0CH	1.13	1.18	1.23		
			CN4-0 = 0DH	1.15	1.20	1.25		
			CN4-0 = 0EH	1.17	1.22	1.27		
			CN4-0 = 0FH	1.19	1.24	1.29		
			CN4-0 = 10H	1.21	1.26	1.31		
			CN4-0 = 11H	1.23	1.28	1.33		
			CN4-0 = 12H	1.25	1.30	1.35		
			CN4-0 = 13H	1.27	1.32	1.37		
			CN4-0 = 14H <sup>*1</sup>	1.29	1.34	1.39		
			CN4-0 = 15H <sup>*1</sup>	1.31	1.36	1.41		
			CN4-0 = 16H <sup>*1</sup>	1.33	1.38	1.43		
			CN4-0 = 17H <sup>*1</sup>	1.35	1.40	1.45		
CN4-0 = 18H <sup>*1</sup>	1.37	1.42	1.47					
CN4-0 = 19H <sup>*1</sup>	1.39	1.44	1.49					
CN4-0 = 1AH <sup>*1</sup>	1.41	1.46	1.51					
CN4-0 = 1BH <sup>*1</sup>	1.43	1.48	1.53					
CN4-0 = 1CH <sup>*1</sup>	1.45	1.50	1.55					
CN4-0 = 1DH <sup>*1</sup>	1.47	1.52	1.57					
CN4-0 = 1EH <sup>*1</sup>	1.49	1.54	1.59					
CN4-0 = 1FH <sup>*1</sup>	1.51	1.56	1.61					
V <sub>L1</sub> temperature deviation	ΔV <sub>L1</sub>	V <sub>DD</sub> = 3.0V	—	-1.5	—	mV/°C		
V <sub>L1</sub> voltage dependency	ΔV <sub>L1</sub>	V <sub>DD</sub> = 1.3 to 3.6V	—	5	20	mV/V		
V <sub>L2</sub> voltage	V <sub>L2</sub>	V <sub>DD</sub> = 3.0V, T <sub>j</sub> = 25°C 300kΩ load (V <sub>L4</sub> -V <sub>SS</sub> )	Typ. -10%	V <sub>L1</sub> ×2	Typ. +4%	V		
V <sub>L3</sub> voltage	V <sub>L3</sub>	V <sub>DD</sub> = 3.0V, T <sub>j</sub> = 25°C	Typ. -10%	V <sub>L1</sub> ×2	Typ. +4%			
V <sub>L4</sub> voltage	V <sub>L4</sub>	300kΩ load (V <sub>L4</sub> -V <sub>SS</sub> )	1/3 bias	V <sub>L1</sub> ×3	Typ. +4%			
			1/4 bias	V <sub>L1</sub> ×3	Typ. +5%			
LCD bias voltage generation time	T <sub>BIAS</sub>	—	—	—	600	ms		

\*1: When using 1/4 bias, the V<sub>L1</sub> voltage is set to typ. 1.32 V (same voltage as in CN4-0 = 13H).

## DC CHARACTERISTICS (3/5)

(V<sub>DD</sub> = 1.1 to 3.6V, AV<sub>DD</sub> = 2.2 to 3.6V, V<sub>SS</sub> = AV<sub>SS</sub> = 0V, Ta = -20 to +70°C, unless otherwise specified) (3/5)

Parameter	Symbol	Condition	Rating			Unit	Measuring circuit
			Min.	Typ.	Max.		
BLD threshold voltage	V <sub>BLD</sub>	V <sub>DD</sub> = 1.35 to 3.6V	LD2-0 = 0H	Typ. -2%	1.35	Typ. +2%	V
			LD2-0 = 1H		1.4		
			LD2-0 = 2H		1.45		
			LD2-0 = 3H		1.5		
			LD2-0 = 4H		1.6		
			LD2-0 = 5H		1.7		
			LD2-0 = 6H		1.8		
			LD2-0 = 7H		1.9		
			LD2-0 = 8H		2.0		
			LD2-0 = 9H		2.1		
			LD2-0 = 0AH		2.2		
			LD2-0 = 0BH		2.3		
			LD2-0 = 0CH		2.4		
			LD2-0 = 0DH		2.5		
LD2-0 = 0EH	2.7						
LD2-0 = 0FH	2.9						
BLD threshold voltage temperature deviation	ΔV <sub>BLD</sub>	V <sub>DD</sub> = 1.35 to 3.6V		0.1	—	%/°C	
Supply current 1	IDD1	CPU: In STOP state. Low-speed/high-speed oscillation: stopped.	Ta = 25°C —	0.15	0.50	μA	1
			Ta = -20 to +70°C —	—	2.50		
Supply current 2	IDD2	CPU: In HALT state (LTBC, RTC: Operating <sup>*3*5</sup> ). High-speed oscillation: Stopped. LCD/BIAS circuits: Stopped.	Ta = 25°C —	0.5	1.3	μA	
			Ta = -20 to +70°C —	—	3.5		
Supply current 3	IDD3	CPU: In 32.768kHz operating state. <sup>*1*3</sup> High-speed oscillation: Stopped. LCD/BIAS circuits: Operating. <sup>*2</sup>	Ta = 25°C —	5	7	μA	
			Ta = -20 to +70°C —	—	12		
Supply current 4	IDD4	CPU: In 500kHz CR operating state. LCD/BIAS circuits: Operating. <sup>*2</sup>	Ta = 25°C —	70	85	μA	
			Ta = -20 to +70°C —	—	100		
Supply current 5	IDD5	CPU: In 4.096MHz operating state. <sup>*2*3</sup> PLL: In oscillating state. LCD/BIAS circuits: Operating. <sup>*2</sup> V <sub>DD</sub> = 1.8 to 3.6V	Ta = 25°C —	0.8	1.0	mA	
			Ta = -20 to +70°C —	—	1.2		
Supply current 6	IDD6	CPU: In 4.096MHz operating state. <sup>*2</sup> PLL: In oscillating state. <sup>*3*4</sup> A/D: In operating state. LCD/BIAS circuits: Operating. <sup>*2</sup> V <sub>DD</sub> = AV <sub>DD</sub> = 3.0V	Ta = 25°C —	1.5	1.6	mA	
			Ta = -20 to +70°C —	—	2.5		

\*1: When the CPU operating rate is 100% (No HALT state).

\*2: All SEGs: off waveform, No LCD panel load, 1/3 bias, 1/3 duty, Frame frequency: Approx. 64 Hz, Bias voltage multiplying clock: 1/128 LSCLK (256Hz)

\*3: Use 32.768KHz Crystal Oscillator C-001R (Epson Toyocom) with capacitance C<sub>GL</sub>/C<sub>DL</sub> = 0pF.

\*4: Use 4.096MHz Crystal Oscillator HC49SFWB (Kyocera).

\*5: Significant bits of BLKCON0~BLKCON4 registers are all "1".

DC CHARACTERISTICS (4/5)

(V<sub>DD</sub> = 1.1 to 3.6V, AV<sub>DD</sub> = 2.2 to 3.6V, V<sub>SS</sub> = AV<sub>SS</sub> = 0V, Ta = -20 to +70°C, unless otherwise specified) (4/5)

Parameter	Symbol	Condition	Rating			Unit	Measuring circuit	
			Min.	Typ.	Max.			
Output voltage 1 (P20-P22/2 <sup>nd</sup> function is selected) (P30-P35) (P40-P47) (PA0-PA7) <sup>*1</sup>	VOH1	IOH1 = -0.5mA, V <sub>DD</sub> = 1.8 to 3.6V	V <sub>DD</sub> -0.5	—	—	V	2	
		IOH1 = -0.1mA, V <sub>DD</sub> = 1.3 to 3.6V	V <sub>DD</sub> -0.3	—	—			
		IOH1 = -0.03mA, V <sub>DD</sub> = 1.1 to 3.6V	V <sub>DD</sub> -0.3	—	—			
	VOL1	IOL1 = +0.5mA, V <sub>DD</sub> = 1.8 to 3.6V	—	—	0.5			
		IOL1 = +0.1mA, V <sub>DD</sub> = 1.3 to 3.6V	—	—	0.5			
		IOL1 = +0.03mA, V <sub>DD</sub> = 1.1 to 3.6V	—	—	0.3			
Output voltage 2 (P20-P22/2 <sup>nd</sup> function is Not selected)	VOH2	IOH1 = -0.5mA, V <sub>DD</sub> = 1.8 to 3.6V	V <sub>DD</sub> -0.5	—	—			
		IOH1 = -0.1mA, V <sub>DD</sub> = 1.3 to 3.6V	V <sub>DD</sub> -0.3	—	—			
		IOH1 = -0.03mA, V <sub>DD</sub> = 1.1 to 3.6V	V <sub>DD</sub> -0.3	—	—			
	VOL2	IOL2 = +5mA, V <sub>DD</sub> = 1.8 to 3.6V	—	—	0.5			
Output voltage 3 (P40-P41)	VOL3	IOL3 = +3mA, V <sub>DD</sub> = 2.0 to 3.6V (when I <sup>2</sup> C mode is selected)	—	—	0.4			
Output voltage 4 (COM0-15) (COM16-23) <sup>*2</sup> (SEG0-63)	VOH4	IOH4 = -0.2mA, VL1=1.2V	V <sub>L4</sub> -0.2	—	—			
	VOMH4	IOMH4 = +0.2mA, VL1=1.2V	—	—	V <sub>L3</sub> +0.2			
	VOMH4S	IOMH4S = -0.2mA, VL1=1.2V	V <sub>L3</sub> -0.2	—	—			
	VOM4	IOM4 = +0.2mA, VL1=1.2V	—	—	V <sub>L2</sub> +0.2			
	VOM4S	IOM4S = -0.2mA, VL1=1.2V	V <sub>L2</sub> -0.2	—	—			
	VOML4	IOML4 = +0.2mA, VL1=1.2V	—	—	V <sub>L1</sub> +0.2			
	VOML4S	IOML4S = -0.2mA, VL1=1.2V	V <sub>L1</sub> -0.2	—	—			
	VOL4	IOL4 = +0.2mA, VL1=1.2V	—	—	0.2			
Output leakage (P20-P22) (P30-P35) (P40-P47) (PA0-PA7) <sup>*1</sup>	IOOH	VOH = V <sub>DD</sub> (in high-impedance state)	—	—	1	μA	3	
	IOOL	VOL = V <sub>SS</sub> (in high-impedance state)	-1	—	—			
Input current 1 (RESET_N)	IIH1	VIH1 = V <sub>DD</sub>	0	—	1	μA	4	
	IIL1	VIL1 = V <sub>SS</sub>	V <sub>DD</sub> = 1.8 to 3.6V	-600	-300			-20
			V <sub>DD</sub> = 1.3 to 3.6V	-600	-300			-10
V <sub>DD</sub> = 1.1 to 3.6V			-600	-300	-2			
Input current 1 (TEST)	IIH1	VIH1 = V <sub>DD</sub>	V <sub>DD</sub> = 1.8 to 3.6V	20	300	600		
			V <sub>DD</sub> = 1.3 to 3.6V	10	300	600		
			V <sub>DD</sub> = 1.1 to 3.6V	2	300	600		
	IIL1	VIL1 = V <sub>SS</sub>	-1	—	—			
Input current 2 (NMI) (P00-P03) (P10-P11) (P30-P35) (P40-P47) (PA0-PA7) <sup>*1</sup>	IIH2	VIH2 = V <sub>DD</sub> (when pulled-down)	V <sub>DD</sub> = 1.8 to 3.6V	2	30	200		
			V <sub>DD</sub> = 1.3 to 3.6V	0.2	30	200		
			V <sub>DD</sub> = 1.1 to 3.6V	0.01	30	200		
	IIL2	VIL2 = V <sub>SS</sub> (when pulled-up)	V <sub>DD</sub> = 1.8 to 3.6V	-200	-30	-2		
			V <sub>DD</sub> = 1.3 to 3.6V	-200	-30	-0.2		
			V <sub>DD</sub> = 1.1 to 3.6V	-200	-30	-0.01		
	IIH2Z	VIH2 = V <sub>DD</sub> (in high-impedance state)	—	—	1			
IIL2Z	VIL2 = V <sub>SS</sub> (in high-impedance state)	-1	—	—				

\*1: ML610Q435 only

\*2: ML610Q436 only

**DC CHARACTERISTICS (5/5)**

( $V_{DD} = 1.1$  to  $3.6V$ ,  $AV_{DD} = 2.2$  to  $3.6V$ ,  $V_{SS} = AV_{SS} = 0V$ ,  $T_a = -20$  to  $+70^\circ C$ , unless otherwise specified) (5/5)

Parameter	Symbol	Condition	Rating			Unit	Measuring circuit
			Min.	Typ.	Max.		
Input voltage 1 (RESET_N) (TEST) (NMI) (P00–P03) (P10–P11) (P31–P35) (P40–P43) (P45–P47) (PA0–PA7) <sup>*1</sup>	VIH1	$V_{DD} = 1.3$ to $3.6V$	0.7 $\times V_{DD}$	—	$V_{DD}$	V	5
		$V_{DD} = 1.1$ to $3.6V$	0.7 $\times V_{DD}$	—	$V_{DD}$		
	VIL1	$V_{DD} = 1.3$ to $3.6V$	0	—	0.3 $\times V_{DD}$		
		$V_{DD} = 1.1$ to $3.6V$	0	—	0.2 $\times V_{DD}$		
Hysteresis width (RESET_N) (TEST_N) (NMI) (P00–P03) (P10–P11) (P31–P35) (P40–P43) (P45–P47) (PA0–PA7) <sup>*1</sup>	$\Delta VT$	$V_{DD} = 2.0$ to $3.6V$	0.05 $\times V_{DD}$	0.18 $\times V_{DD}$	0.4 $\times V_{DD}$	V	5
		$V_{DD} = 1.1$ to $3.6V$	0.02 $\times V_{DD}$	0.18 $\times V_{DD}$	0.4 $\times V_{DD}$		
Input voltage 2 (P30, P44)	VIH2	—	0.7 $\times V_{DD}$	—	$V_{DD}$	pF	—
	VIL2	—	0	—	0.3 $\times V_{DD}$		
Input pin capacitance (NMI) (P00–P03) (P10–P11) (P30–P35) (P40–P47) (PA0–PA7) <sup>*1</sup>	CIN	$f = 10kHz$ $V_{rms} = 50mV$ $T_a = 25^\circ C$	—	—	5	pF	—

\*1: ML610Q435 only

**HYSTERESIS WIDTH**

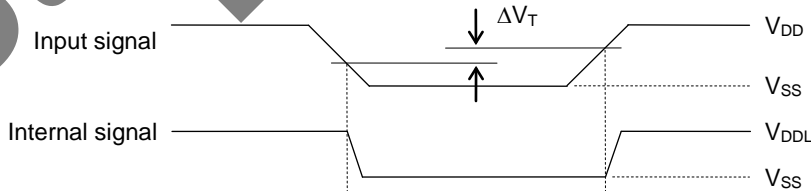

MEASURING CIRCUITS

MEASURING CIRCUIT 1

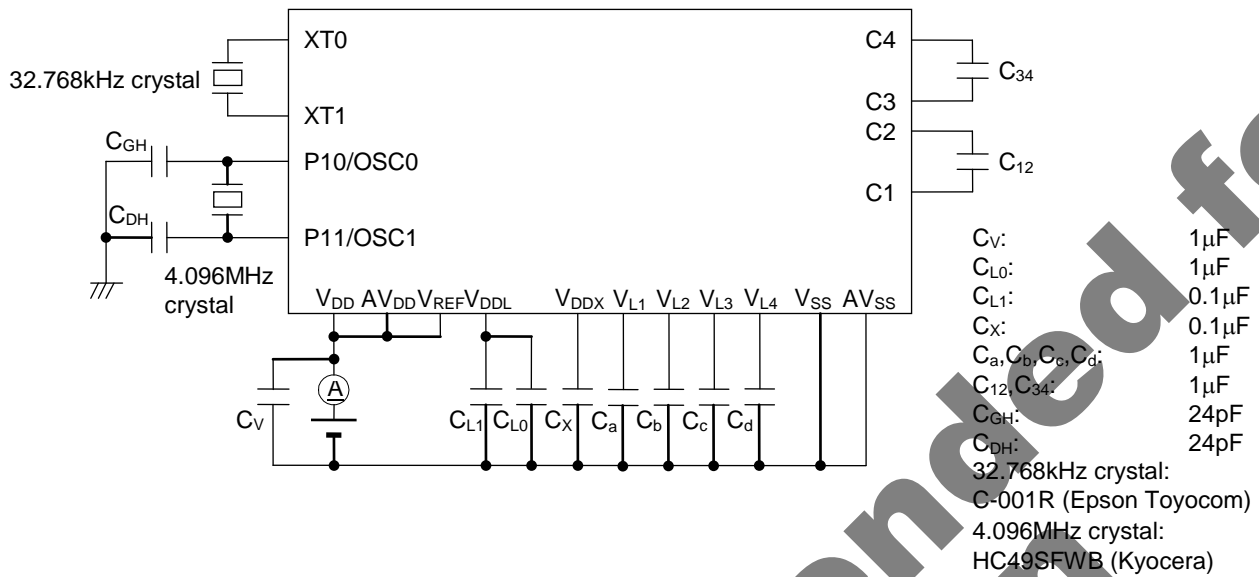

MEASURING CIRCUIT 2

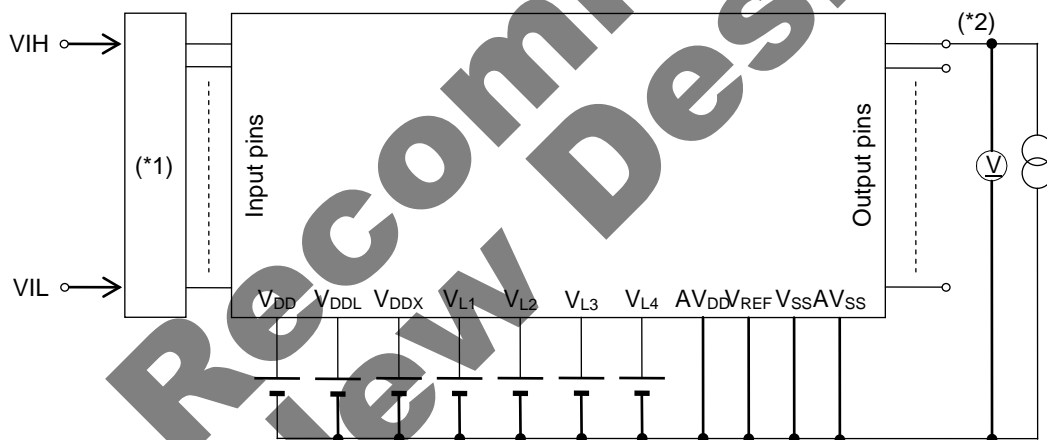

(\*1) Input logic circuit to determine the specified measuring conditions.

(\*2) Measured at the specified output pins.

MEASURING CIRCUIT 3

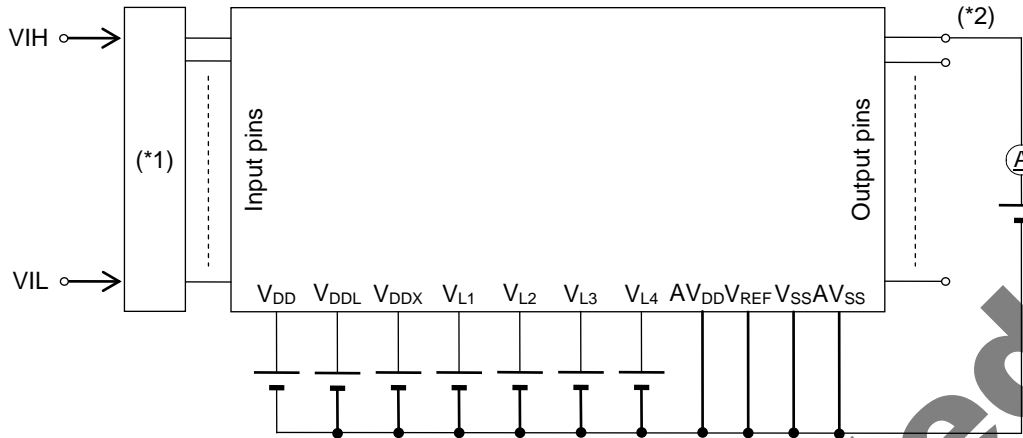

\*1: Input logic circuit to determine the specified measuring conditions.  
 \*2: Measured at the specified output pins.

MEASURING CIRCUIT 4

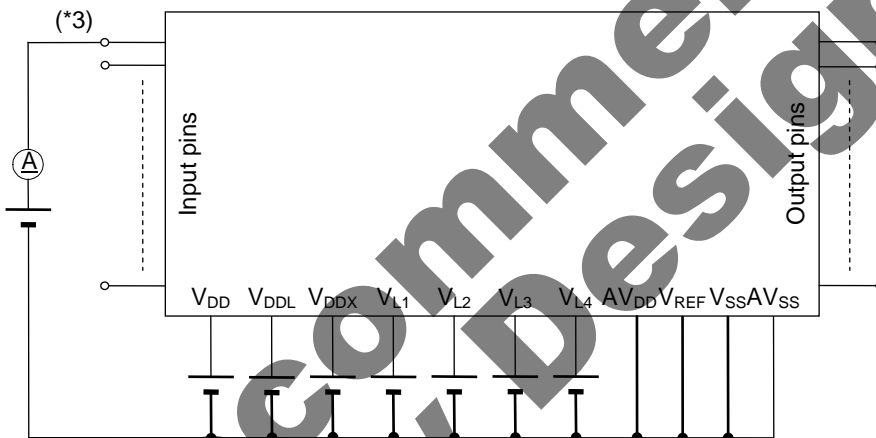

\*3: Measured at the specified output pins.

MEASURING CIRCUIT 5

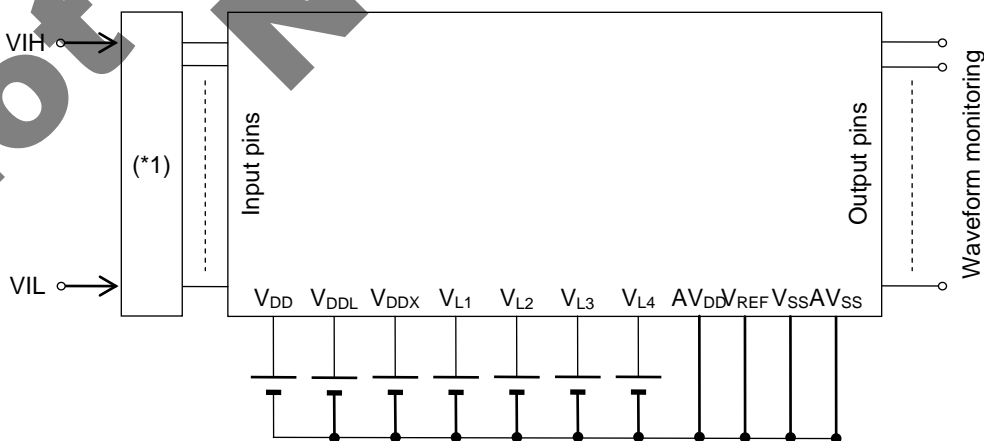

\*1: Input logic circuit to determine the specified measuring conditions.

**AC CHARACTERISTICS (External Interrupt)**

(V<sub>DD</sub> = 1.1 to 3.6V, AV<sub>DD</sub> = 2.2 to 3.6V, V<sub>SS</sub> = AV<sub>SS</sub> = 0V, Ta = -20 to +70°C, unless otherwise specified)

Parameter	Symbol	Condition	Rating			Unit
			Min.	Typ.	Max.	
External interrupt disable period	T <sub>NUL</sub>	Interrupt: Enabled (MIE = 1), CPU: NOP operation System clock: 32.768kHz	76.8	—	106.8	μs

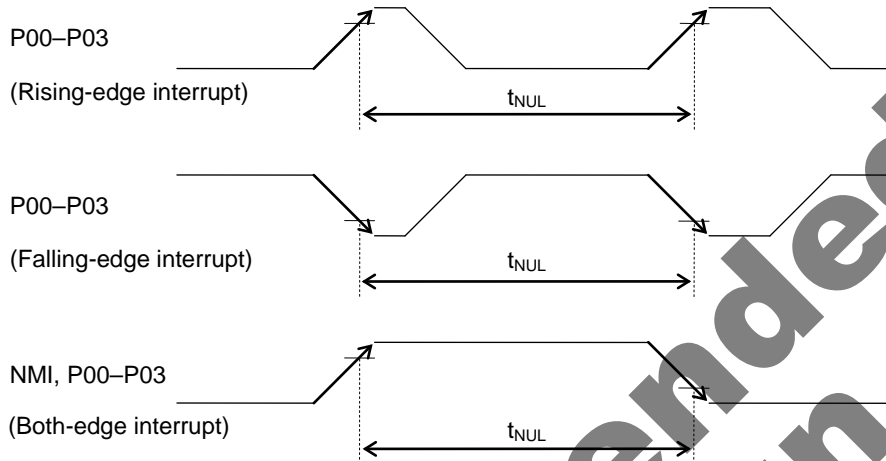

**AC CHARACTERISTICS (UART)**

(V<sub>DD</sub> = 1.3 to 3.6V, AV<sub>DD</sub> = 2.2 to 3.6V, V<sub>SS</sub> = AV<sub>SS</sub> = 0V, Ta = -20 to +70°C, unless otherwise specified)

Parameter	Symbol	Condition	Rating			Unit
			Min.	Typ.	Max.	
Transmit baud rate	t <sub>TBRT</sub>	—	—	BRT <sup>*1</sup>	—	s
Receive baud rate	t <sub>RBRT</sub>	—	BRT <sup>*1</sup> -3%	BRT <sup>*1</sup>	BRT <sup>*1</sup> +3%	s

\*1: Baud rate period (including the error of the clock frequency selected) set with the UART0 baud rate register (UA0BRTL,H) and the UART0 mode register 0 (UA0MOD0).

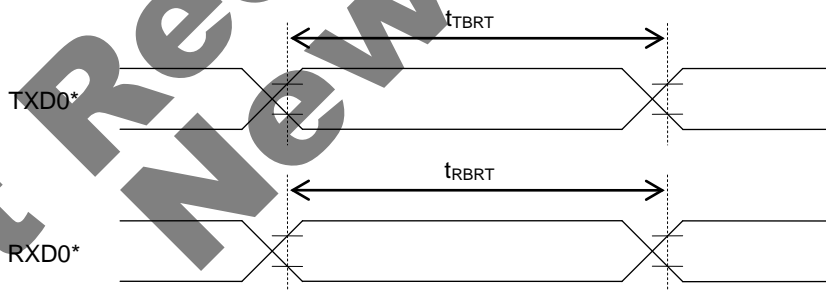

\*: Indicates the secondary function of the port.



## AC CHARACTERISTICS (Synchronous Serial Port)

(V<sub>DD</sub> = 1.3 to 3.6V, AV<sub>DD</sub> = 2.2 to 3.6V, V<sub>SS</sub> = AV<sub>SS</sub> = 0V, Ta = -20 to +70°C, unless otherwise specified)

Parameter	Symbol	Condition	Rating			Unit
			Min.	Typ.	Max.	
SCLK input cycle (slave mode)	t <sub>SCYC</sub>	When RC oscillation is active* <sup>2</sup> (V <sub>DD</sub> = 1.3 to 3.6V)	10	—	—	μs
		When high-speed oscillation is active* <sup>3</sup> (V <sub>DD</sub> = 1.8 to 3.6V)	1	—	—	μs
SCLK output cycle (master mode)	t <sub>SCYC</sub>	—	—	SCLK* <sup>1</sup>	—	s
SCLK input pulse width (slave mode)	t <sub>SW</sub>	When RC oscillation is active* <sup>2</sup> (V <sub>DD</sub> = 1.3 to 3.6V)	4	—	—	μs
		When high-speed oscillation is active* <sup>3</sup> (V <sub>DD</sub> = 1.8 to 3.6V)	0.4	—	—	μs
SCLK output pulse width (master mode)	t <sub>SW</sub>	—	SCLK* <sup>1</sup> ×0.4	SCLK* <sup>1</sup> ×0.5	SCLK* <sup>1</sup> ×0.6	s
SOUT output delay time (slave mode)	t <sub>SD</sub>	When RC oscillation is active* <sup>2</sup> (V <sub>DD</sub> = 1.3 to 3.6V)	—	—	500	ns
		When high-speed oscillation is active* <sup>3</sup> (V <sub>DD</sub> = 1.8 to 3.6V)	—	—	240	
SOUT output delay time (master mode)	t <sub>SD</sub>	When RC oscillation is active* <sup>2</sup> (V <sub>DD</sub> = 1.3 to 3.6V)	—	—	500	ns
		When high-speed oscillation is active* <sup>3</sup> (V <sub>DD</sub> = 1.8 to 3.6V)	—	—	240	
SIN input setup time (slave mode)	t <sub>SS</sub>	—	80	—	—	ns
SIN input setup time (master mode)	t <sub>SS</sub>	When RC oscillation is active* <sup>2</sup> (V <sub>DD</sub> = 1.3 to 3.6V)	500	—	—	ns
		When high-speed oscillation is active* <sup>3</sup> (V <sub>DD</sub> = 1.8 to 3.6V)	240	—	—	
SIN input hold time	t <sub>SH</sub>	When RC oscillation is active* <sup>2</sup> (V <sub>DD</sub> = 1.3 to 3.6V)	300	—	—	ns
		When high-speed oscillation is active* <sup>3</sup> (V <sub>DD</sub> = 1.8 to 3.6V)	80	—	—	

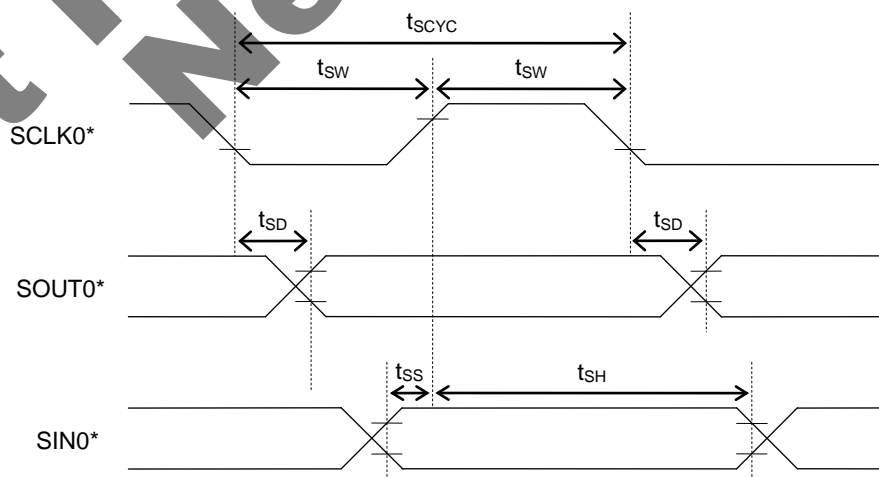
\*<sup>1</sup>: Clock period selected with SOCK3-0 of the serial port 0 mode register (SIO0MOD1)\*<sup>2</sup>: When RC oscillation is selected with OSCM1-0 of the frequency control register (FCON0)\*<sup>3</sup>: When Crystal/ceramic oscillation, built-in PLL oscillation, or external clock input is selected with OSCM1-0 of the frequency control register (FCON0)

\*: Indicates the secondary function of the port.

**AC CHARACTERISTICS (I<sup>2</sup>C Bus Interface: Standard Mode 100kHz)**(V<sub>DD</sub> = 1.8 to 3.6V, AV<sub>DD</sub> = 2.2 to 3.6V, V<sub>SS</sub> = AV<sub>SS</sub> = 0V, Ta = -20 to +70°C, unless otherwise specified)

Parameter	Symbol	Condition	Rating			Unit
			Min.	Typ.	Max.	
SCL clock frequency	f <sub>SCL</sub>	—	0	—	100	kHz
SCL hold time (start/restart condition)	t <sub>HD:STA</sub>	—	4.0	—	—	μs
SCL "L" level time	t <sub>LOW</sub>	—	4.7	—	—	μs
SCL "H" level time	t <sub>HIGH</sub>	—	4.0	—	—	μs
SCL setup time (restart condition)	t <sub>SU:STA</sub>	—	4.7	—	—	μs
SDA hold time	t <sub>HD:DAT</sub>	—	0	—	3.45	μs
SDA setup time	t <sub>SU:DAT</sub>	—	0.25	—	—	μs
SDA setup time (stop condition)	t <sub>SU:STO</sub>	—	4.0	—	—	μs
Bus-free time	t <sub>BUF</sub>	—	4.7	—	—	μs

**AC CHARACTERISTICS (I2C Bus Interface: Fast Mode 400kHz)**(V<sub>DD</sub> = 1.8 to 3.6V, AV<sub>DD</sub> = 2.2 to 3.6V, V<sub>SS</sub> = AV<sub>SS</sub> = 0V, Ta = -20 to +70°C, unless otherwise specified)

Parameter	Symbol	Condition	Rating			Unit
			Min.	Typ.	Max.	
SCL clock frequency	f <sub>SCL</sub>	—	0	—	400	kHz
SCL hold time (start/restart condition)	t <sub>HD:STA</sub>	—	0.6	—	—	μs
SCL "L" level time	t <sub>LOW</sub>	—	1.3	—	—	μs
SCL "H" level time	t <sub>HIGH</sub>	—	0.6	—	—	μs
SCL setup time (restart condition)	t <sub>SU:STA</sub>	—	0.6	—	—	μs
SDA hold time	t <sub>HD:DAT</sub>	—	0	—	0.9	μs
SDA setup time	t <sub>SU:DAT</sub>	—	0.1	—	—	μs
SDA setup time (stop condition)	t <sub>SU:STO</sub>	—	0.6	—	—	μs
Bus-free time	t <sub>BUF</sub>	—	1.3	—	—	μs

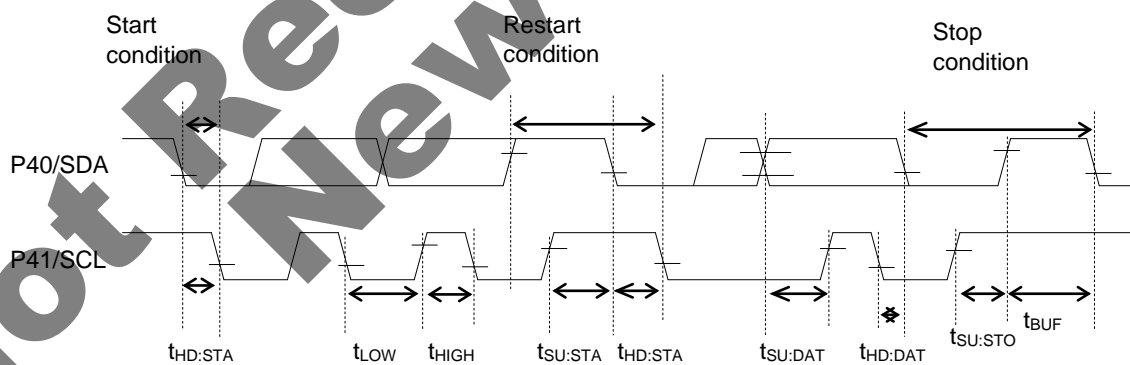

**AC CHARACTERISTICS (RC Oscillation A/D Converter)**

(V<sub>DD</sub> = 1.3 to 3.6V, AV<sub>DD</sub> = 2.2 to 3.6V, V<sub>SS</sub> = AV<sub>SS</sub> = 0V, Ta = -20 to +70°C, unless otherwise specified)

Parameter	Symbol	Condition	Rating			Unit
			Min.	Typ.	Max.	
Resistors for oscillation	RS0, RS1, RT0, RT0-1,RT1	CS0, CT0, CS1 ≥ 740pF	1	—	—	kΩ
Oscillation frequency VDD = 1.5V	f <sub>OSC1</sub>	Resistor for oscillation = 1kΩ	209.4	330.6	435.1	kHz
	f <sub>OSC2</sub>	Resistor for oscillation = 10kΩ	41.29	55.27	64.16	kHz
	f <sub>OSC3</sub>	Resistor for oscillation = 100kΩ	4.71	5.97	7.06	kHz
RS to RT oscillation frequency ratio *1 VDD = 1.5V	Kf1	RT0, RT0-1, RT1 = 1kHz	5.567	5.982	6.225	—
	Kf2	RT0, RT0-1, RT1 = 10kHz	0.99	1	1.01	—
	Kf3	RT0, RT0-1, RT1 = 100kHz	0.104	0.108	0.118	—
Oscillation frequency VDD = 3.0V	f <sub>OSC1</sub>	Resistor for oscillation = 1kΩ	407.3	486.7	594.6	kHz
	f <sub>OSC2</sub>	Resistor for oscillation = 10kΩ	49.76	59.28	72.76	kHz
	f <sub>OSC3</sub>	Resistor for oscillation = 100kΩ	5.04	5.993	7.04	kHz
RS to RT oscillation frequency ratio *1 VDD = 3.0V	Kf1	RT0, RT0-1, RT1 = 1kHz	8.006	8.210	8.416	—
	Kf2	RT0, RT0-1, RT1 = 10kHz	0.99	1	1.01	—
	Kf3	RT0, RT0-1, RT1 = 100kHz	0.100	0.108	0.115	—

\*1: Kfx is the ratio of the oscillation frequency by the sensor resistor to the oscillation frequency by the reference resistor on the same conditions.

$$Kfx = \frac{f_{oscx}(RT0-CS0 \text{ oscillation})}{f_{oscx}(RS0-CS0 \text{ oscillation})}, \quad \frac{f_{oscx}(RT0-1-CS0 \text{ oscillation})}{f_{oscx}(RS0-CS0 \text{ oscillation})}, \quad \frac{f_{oscx}(RT1-CS1 \text{ oscillation})}{f_{oscx}(RS1-CS1 \text{ oscillation})}$$

(x = 1, 2, 3)

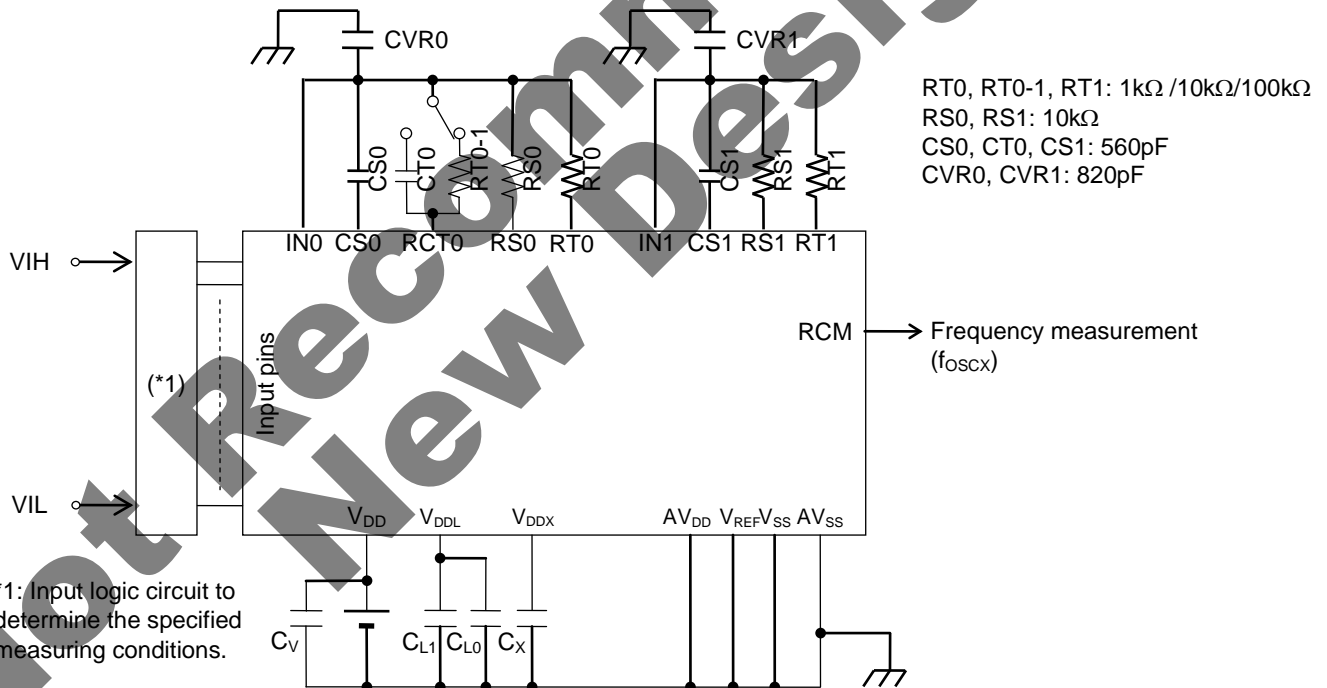

\*1: Input logic circuit to determine the specified measuring conditions.

**Note:**

- Please have the shortest layout for the common node (wiring patterns which are connected to the external capacitors, resistors and IN0/IN1 pin), including CVR0/CVR1. Especially, do not have long wire between IN0/IN1 and RS0/RS1. The coupling capacitance on the wires may occur incorrect A/D conversion. Also, please do not have signals which may be a source of noise around the node.
- When RT0/RT1 (Thermistor and etc.) requires long wiring due to the restricted placement, please have VSS(GND) trace next to the signal.
- Please make wiring to components (capacitor, resistor and etc.) necessary for objective measurement. Wiring to reserved components may affect to the A/D conversion operation by noise the components itself may have.

**Electrical Characteristics of Successive Approximation Type A/D Converter**

( $V_{DD} = 1.8$  to  $3.6V$ ,  $AV_{DD} = 2.2$  to  $3.6V$ ,  $V_{SS} = AV_{SS} = 0V$ ,  $T_a = -20$  to  $+70^\circ C$ , unless otherwise specified)

Parameter	Symbol	Condition	Rating			Unit
			Min.	Typ.	Max.	
Resolution	n	—	—	—	12	bit
Integral non-linearity error	IDL	$2.7V \leq V_{REF} \leq 3.6V$	-4	—	+4	LSB
		$2.2V \leq V_{REF} \leq 2.7V$	-6	—	+6	
Differential non-linearity error	DNL	$2.7V \leq V_{REF} \leq 3.6V$	-3	—	+3	LSB
		$2.2V \leq V_{REF} \leq 2.7V$	-5	—	+5	
Zero-scale error	$V_{OFF}$	—	-6	—	+6	LSB
Full-scale error	FSE	—	-6	—	+6	
Reference voltage	$V_{REF}$	—	2.2	—	$AV_{DD}$	
Conversion time	$t_{CONV}$	SACK = 0 (HSCLK = 375kHz to 625kHz)	—	25	—	$\phi/CH$
		SACK = 1 (HSCLK = 1.5MHz to 4.2MHz)	—	112	—	

$\phi$ : Period of high-speed clock (HSCLK)

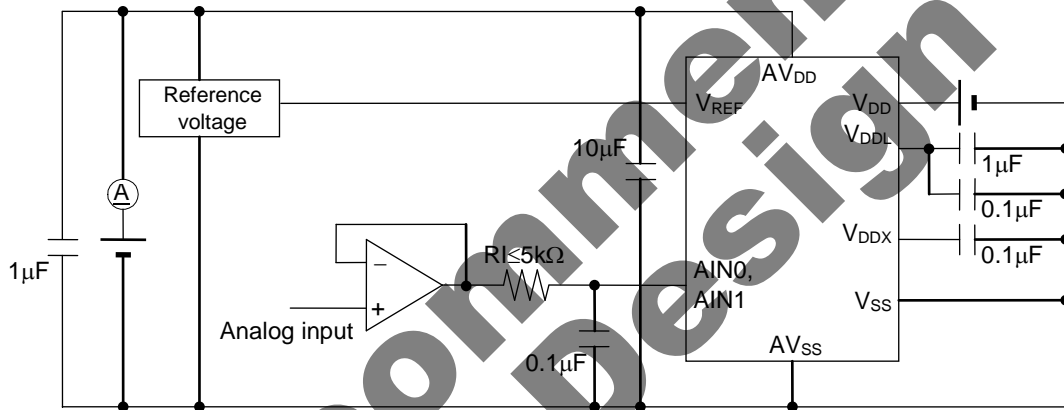

Package Dimensions

(Unit: mm)

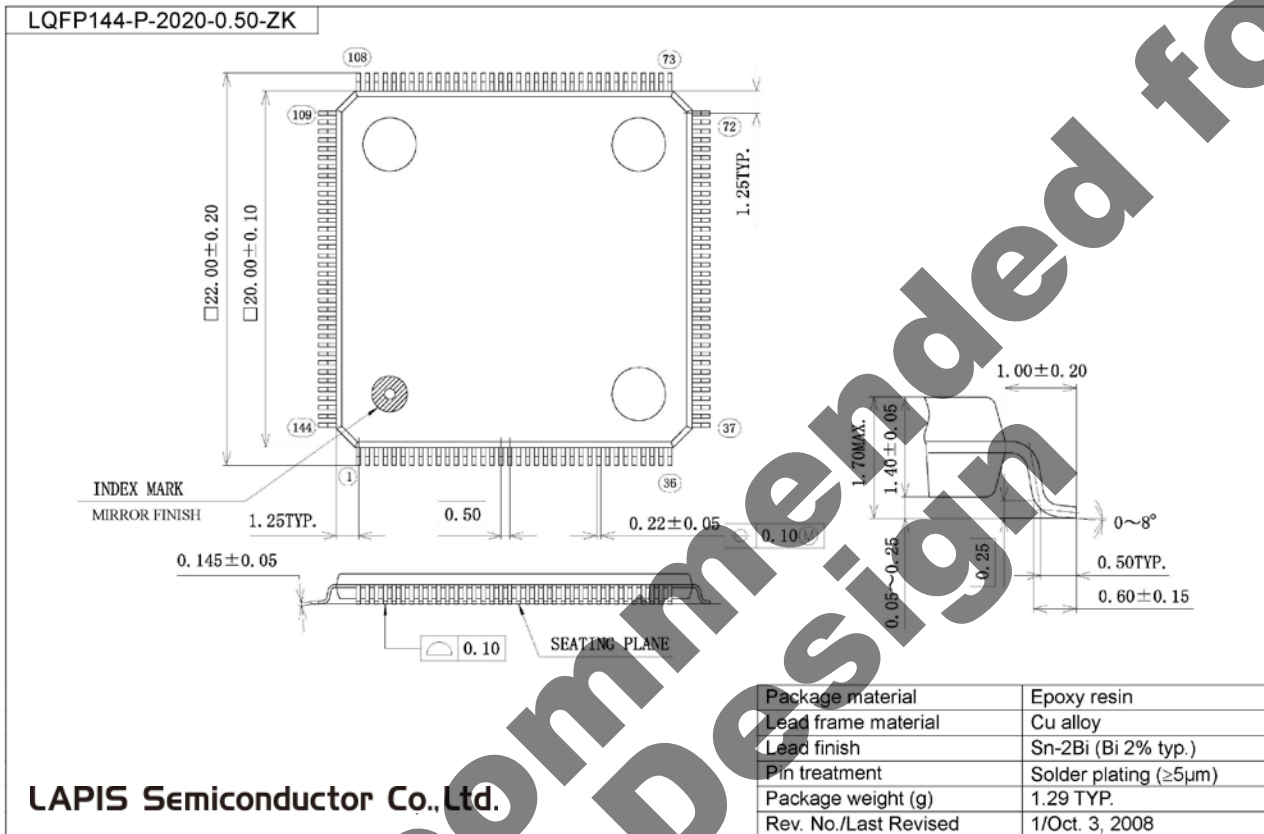

Notes for Mounting the Surface Mount Type Package

The surface mount type packages are very susceptible to heat in reflow mounting and humidity absorbed in storage. Therefore, before you perform reflow mounting, contact a ROHM sales office for the product name, package name, pin number, package code and desired mounting conditions (reflow method, temperature and times).

## REVISION HISTORY

Document No.	Date	Page		Description
		Previous Edition	Current Edition	
FEDL610Q435-01	Sep.13,2010	–	–	Final edition 1
FEDL610Q435-02	Feb.2,2011	3	3	The product name of A version is added.
		4	4	Terminal name CRT0 is corrected to RCT0.
		5	5	Terminal name CRT0 is corrected to RCT0.
		17	17	The direction of I/O of T02P0CK is corrected not to "O" but to "I."
		18	18	Terminal name CRT0 is corrected to RCT0.
		21	21	Part number CHC49SFWB is corrected to HC49SFWB.
		23	23	
		23	23	Typ value"0" of a BLD threshold voltage temperature deviation is corrected to "0.1."
		24	24	The terminal name P36 of the output voltage 1 is corrected to P35.Add the conditions of "**2".
		29	29	The table of the exchange characteristic is substituted.
		33	33	Substitution of a package dimensions.
		FEDL610Q435-03	Apr.8.2015	All
3	4			Change from "Shipment" to "Product name – Supported Function"
-	22			Add CLOCK GENERATION CIRCUIT OPERATING CONDITIONS
21	23			Change "RESET" to "Reset pulse width (P <sub>RST</sub> ) " and "Power-on reset activation power rise time (T <sub>POR</sub> ) ".
35	37			Change description in Notes.
2	2			Corrected a typo. "100kbps@1MHz HSCLK" is corrected to 100kbps@4MHz HSCLK.

**NOTES**

- 1) The information contained herein is subject to change without notice.
- 2) Although LAPIS Semiconductor is continuously working to improve product reliability and quality, semiconductors can break down and malfunction due to various factors. Therefore, in order to prevent personal injury or fire arising from failure, please take safety measures such as complying with the derating characteristics, implementing redundant and fire prevention designs, and utilizing backups and fail-safe procedures. LAPIS Semiconductor shall have no responsibility for any damages arising out of the use of our Products beyond the rating specified by LAPIS Semiconductor.
- 3) Examples of application circuits, circuit constants and any other information contained herein are provided only to illustrate the standard usage and operations of the Products. The peripheral conditions must be taken into account when designing circuits for mass production.
- 4) The technical information specified herein is intended only to show the typical functions of the Products and examples of application circuits for the Products. No license, expressly or implied, is granted hereby under any intellectual property rights or other rights of LAPIS Semiconductor or any third party with respect to the information contained in this document; therefore LAPIS Semiconductor shall have no responsibility whatsoever for any dispute, concerning such rights owned by third parties, arising out of the use of such technical information.
- 5) The Products are intended for use in general electronic equipment (i.e. AV/OA devices, communication, consumer systems, gaming/entertainment sets) as well as the applications indicated in this document.
- 6) The Products specified in this document are not designed to be radiation tolerant.
- 7) For use of our Products in applications requiring a high degree of reliability (as exemplified below), please contact and consult with a LAPIS Semiconductor representative: transportation equipment (i.e. cars, ships, trains), primary communication equipment, traffic lights, fire/crime prevention, safety equipment, medical systems, servers, solar cells, and power transmission systems.
- 8) Do not use our Products in applications requiring extremely high reliability, such as aerospace equipment, nuclear power control systems, and submarine repeaters.
- 9) LAPIS Semiconductor shall have no responsibility for any damages or injury arising from non-compliance with the recommended usage conditions and specifications contained herein.
- 10) LAPIS Semiconductor has used reasonable care to ensure the accuracy of the information contained in this document. However, LAPIS Semiconductor does not warrant that such information is error-free and LAPIS Semiconductor shall have no responsibility for any damages arising from any inaccuracy or misprint of such information.
- 11) Please use the Products in accordance with any applicable environmental laws and regulations, such as the RoHS Directive. For more details, including RoHS compatibility, please contact a ROHM sales office. LAPIS Semiconductor shall have no responsibility for any damages or losses resulting from non-compliance with any applicable laws or regulations.
- 12) When providing our Products and technologies contained in this document to other countries, you must abide by the procedures and provisions stipulated in all applicable export laws and regulations, including without limitation the US Export Administration Regulations and the Foreign Exchange and Foreign Trade Act.
- 13) This document, in part or in whole, may not be reprinted or reproduced without prior consent of LAPIS Semiconductor.

Copyright 2010 - 2015 LAPIS Semiconductor Co., Ltd.

**LAPIS Semiconductor Co.,Ltd.**

2-4-8 Shinyokohama, Kouhoku-ku,  
Yokohama 222-8575, Japan  
<http://www.lapis-semi.com/en/>