

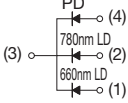









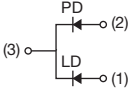

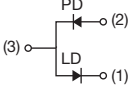

Laser Diodes

Red/Infrared Dual Wavelength Lasers															
Part No.	Pitch (μm)	Wavelength λ _P (nm)	Absolute Maximum Ratings (T _C =25°C)			Electrical and Optical Characteristics (T _C =25°C)							P _O (mW)	Package	Equivalent Circuit
			P _O (mW)	V _R (V)	T _{opr} Max (°C)	I _{TH} (mA)	I _{op} (mA)	η (W/A)	V _{op} (V)	I _m (mA)	θ _⊥ (deg)	θ// (deg)			
RLD2WMNL2-01x (Standard)	110	663	7	2	80	18	24	0.70	2.3	0.25	28	10.0	5		
		785	7	2	80	15	20	0.70	1.8	0.25	32	10.0	5		

Note1: Unless otherwise specified, the Electrical and Optical Characteristics are typical values.
 Note2: The Control number is applied in the x of part No.

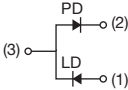
Red Lasers															
Part No.	Wavelength λ _P (nm)	Absolute Maximum Ratings (T _C =25°C)			Electrical and Optical Characteristics (T _C =25°C)							P _O (mW)	Package	Equivalent Circuit	
		P _O (mW)	V _R (V)	T _{opr} Max (°C)	I _{TH} (mA)	I _{op} (mA)	η (W/A)	V _{op} (V)	I _m (mA)	θ _⊥ (deg)	θ// (deg)				
RLD65MZT7	655	7	2	70	20	30	0.70	2.3	0.24	27.0	8.0	5			
RLD63NPC5 (Pure red)	635	6	2	40	24	33	0.55	2.2	0.18	32.0	8.0	5			
RLD63NPC6 (Pure red)	638	12	2	50	28	43	0.70	2.3	0.15	32.0	8.0	10			
RLD63NPC7 (Pure red)	638	17	2	50	32	57	0.60	2.2	0.16	30.0	8.0	15			
RLD63NPC8 (Pure red)	638	24	2	50	32	65	0.60	2.25	0.20	30.0	8.0	20			
RLD65NZX1 (Higher temp.)	663	10	2	80	15	24	0.85	2.3	0.30	27.0	9.0	7			
RLD65NZX2 (Higher ESD)	658	7	2	70	25	33	0.60	2.3	0.20	28.0	8.5	5			
RLD65NZX3 (Higher ESD)	658	12	2	70	25	42	0.60	2.3	0.30	28.0	8.5	10			
RLD65PZX2 (Higher ESD)	658	7	2	70	25	33	0.60	2.3	0.20	28.0	8.5	5			
RLD65PZX3 (Higher ESD)	658	12	2	70	25	42	0.60	2.3	0.30	28.0	8.5	10			

Note: Unless otherwise specified, the Electrical and Optical Characteristics are typical values.

Infrared Lasers															
Part No.	Wavelength λ_p (nm)	Absolute Maximum Ratings (T _c =25°C)			Electrical and Optical Characteristics (T _c =25°C)								P _o (mW)	Package	Equivalent Circuit
		P _o (mW)	V _R (V)	Topr Max (°C)	I _{TH} (mA)	I _{op} (mA)	η (W/A)	V _{op} (V)	I _m (mA)	θ_{\perp} (deg)	$\theta_{//}$ (deg)				
RLD78MZA6	790	4.5	2	70	25	35	0.35	1.9	0.15	37.0	11.0	3			
RLD78MZM7	792	20	2	60	11	33	0.65	1.8	0.50	24.0	8.5	15			
RLD78NZM5	793	10	2	60	10	20	0.55	1.8	1.15	28.0	9.0	6			
RLD78NZM7	792	20	2	60	11	33	0.65	1.8	0.90	24.0	8.5	15			
RLD82NZJ1	822	220	2	60	50	255	0.95	2.4	0.30	17.0	9.5	200			
RLD84NZJ2	842	220	2	60	40	250	0.95	2.4	0.40	19.0	9.5	200			
RLD85NZJ4	852	220	2	60	40	250	0.95	2.4	0.40	19.0	9.5	200			
RLD94NZJ5	942	285	2	65	55	325	0.75	2.2	0.90	30.0	35.0	200			
RLD94NZJ7	942	220	2	60	40	300	0.75	2.4	1.00	17.0	9.5	200			
RLD78PZM7	792	20	2	60	11	33	0.65	1.8	0.65	24.0	8.5	15			
RLD82PZJ1	822	220	2	60	50	255	0.95	2.4	0.30	17.0	9.5	200			
RLD84PZJ2	842	220	2	60	40	250	0.95	2.4	0.40	19.0	9.5	200			
RLD85PZJ4	852	220	2	60	40	250	0.95	2.4	0.40	19.0	9.5	200			
RLD94PZJ5	942	285	2	65	55	325	0.75	2.2	0.90	30.0	35.0	200			
RLD94PZJ7	942	220	2	60	40	300	0.75	2.4	1.00	17.0	9.5	200			

Note: Unless otherwise specified, the Electrical and Optical Characteristics are typical values.

Safety

The light emitted from laser diodes, can cause retinal damage if viewed directly. Never look directly into the laser beam or through any lenses or fibers when the system is operating. For optical axis alignment or other operations, we recommend the use of an infrared-sensitive camera (ITV) or wearing protective goggles.

 VISIBLE LASER RADIATION-AVOID DIRECT EXPOSURE TO BEAM MAXIMUM OUTPUT 500 mW WAVELENGTH 600 to 700nm CLASS IIIb LASER PRODUCT	 VISIBLE SEMICONDUCTOR LASER AVOID EXPOSURE-visible Laser radiation is emitted from this aperture. ROHM Laser Diode This product complies with 21 CFR Part 1040.10 and 1040.11 ROHM Co.,LTD. 21.Saini Mizosaki-cho,Ukyo-ku Kyoto 615.8585, Japan	 INVISIBLE LASER RADIATION-AVOID DIRECT EXPOSURE TO BEAM MAXIMUM OUTPUT 500 mW WAVELENGTH 760 to 990nm CLASS IIIb LASER PRODUCT	 INVISIBLE SEMICONDUCTOR LASER AVOID EXPOSURE-invisible Laser radiation is emitted from this aperture. ROHM Laser Diode This product complies with 21 CFR Part 1040.10 and 1040.11 ROHM Co.,LTD. 21.Saini Mizosaki-cho,Ukyo-ku Kyoto 615.8585, Japan
---	--	---	--

The products described in this specification are designed to be used with ordinary electronic equipment or devices (such as audio-visual equipment, office-automation equipment, communication device, electrical appliances, and electronic toys). If you intend to use these products or devices which require an extremely high level of reliability and malfunction of which would directly endanger human life (such as medical instruments, transportation equipment, aerospace machinery, nuclear-reactor controllers, fuel controllers and other safety devices), please be sure to consult with our sales representative in advance.

About open package products

With the open package product (Package mark is P), the external environment could deteriorate the characteristics and reliability of Laser Diodes. Please be careful to foreign matter including toner, human substance and smoke, corrosion due to ion, the volatilization component from the glue and flux, condensation, optical tweezers effect and etc. Do not touch the components including the laser chip emission point.

Part Numbers

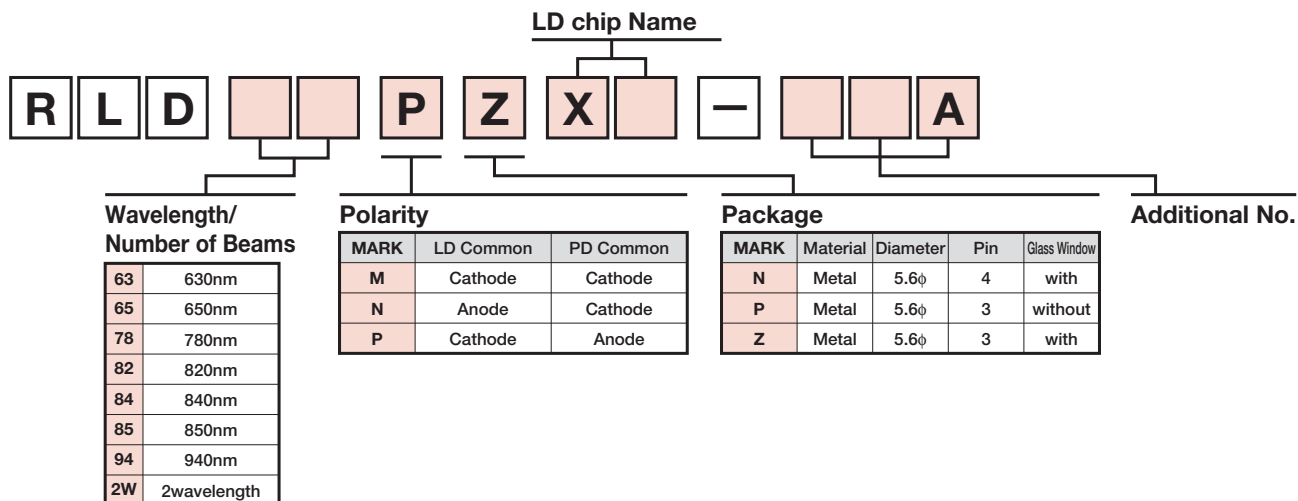

Symbols and Definitions

Absolute Maximum Ratings

Absolute maximum ratings are values which must not be exceeded even momentarily regardless of external conditions. These values are specified for a case temperature T_C of 25°C.

Parameter	Symbol	Definition
Optical Output	P_o	Maximum allowable optical output during continuous or pulse operation. No kinks will appear in the output vs. forward current curve up to this output value. (Fig.1)
Reverse Voltage	V_R	The maximum allowable voltage when a reverse bias is applied to the device. Lasers and photo diodes are rated separately.
Operating Temperature	T_{opr}	Allowed ambient temperature range when the device is in operation. Delined to be the case temperature of the device.
Storage Temperature	T_{stg}	Allowed temperature range when the device is being stored.

Fig.1 Optical Output vs. Forward Current

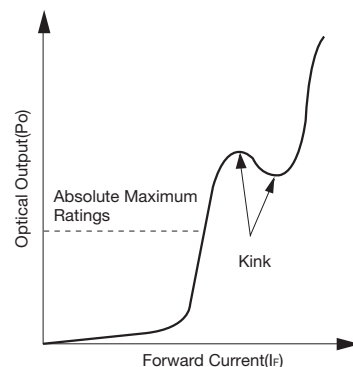

Electrical and Optical Characteristics

Item	Symbol	Definition
Threshold Current	I_{th}	In Fig.2, A is the spontaneous emission range and B is the stimulated emission range. The threshold current is the current at which laser emission begins.
Operating Current	I_{op}	The forward current required to generate the specified optical output.
Operating Voltage	V_{op}	The forward voltage required to generate the specified optical output.
Differential Efficiency	η	The average increase in the output per unit of drive current. In the laser emission range, this is the slope of the linear optical output vs. forward current curve. (Fig.2)
Monitor Current	I_m	When the specified optical output is generated, this is the output current of the photodiode when a specified reverse voltage is applied to the monitor photodiode.
Parallel Divergence Angle Perpendicular Divergence Angle	$\theta_{//}$ θ_{\perp}	Light emitted from the laser spreads as shown in Fig.3. The result of measurements of this spread in the parallel (x) and perpendicular (y) directions with respect to the junction surface is shown in Fig.3. The widths of the spread at the points where the strength drops to 1/2 the peak strength (half value full angles) are defined as angles and called $\theta_{//}$ and θ_{\perp} . (Fig.4)
Parallel Deviation Angle Perpendicular Deviation Angle	$\Delta\phi_{//}$ $\Delta\phi_{\perp}$	These values express the deviation of the optical axis with respect to the reference plane, and are defined for the parallel and perpendicular spread angles (Fig.4) to be (a - b)/2 (Fig.5).
Emission Point Accuracy	$\Delta X, \Delta Y, \Delta Z$	This indicates the amount of deviation of the emission point. ΔX and ΔY indicate deviation from the center of the package, and ΔZ indicates deviation from the reference plane. (Fig.6)
Peak Emission Wavelength	λ	Peak emission wavelength when generating the specified output. As shown in Fig.7, the emission spectrum has both a single mode and a multimode. In the multimode, the wavelength is defined as the wavelength with the highest intensity.

Fig.2 Optical Output vs. Forward Current

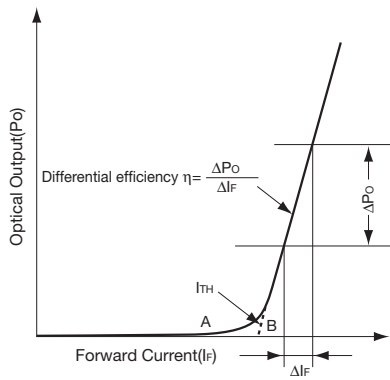

Fig.3 Radiation Characteristics

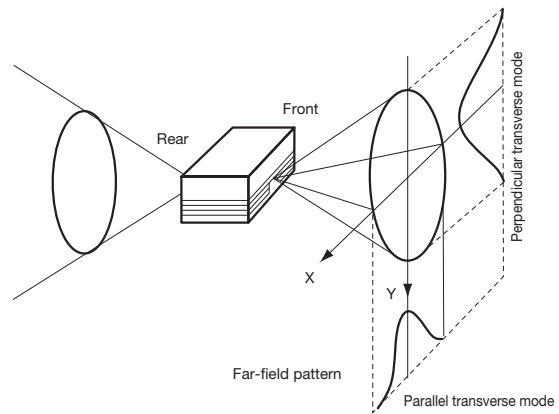

Fig.4 Radiation Characteristics

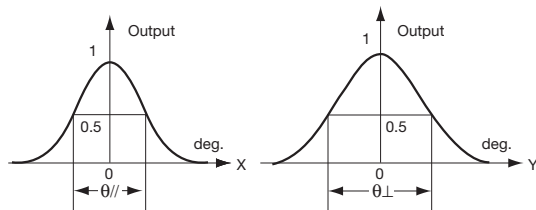

Fig.5 Deviation Angle

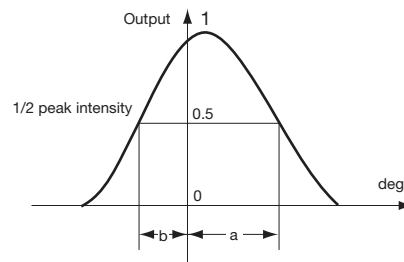

Fig.6 Deviation Angle

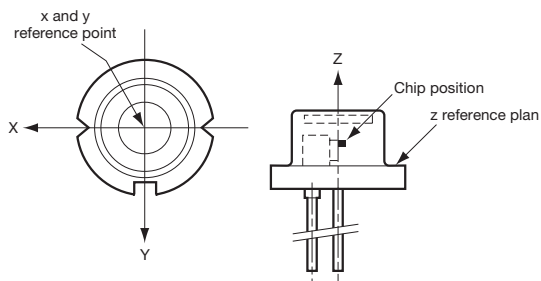
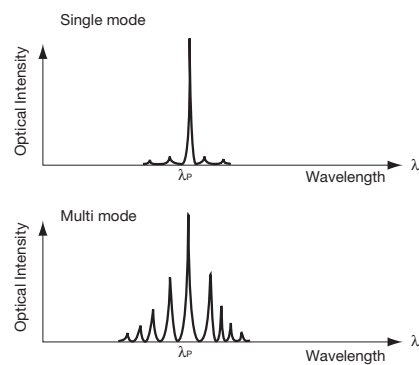
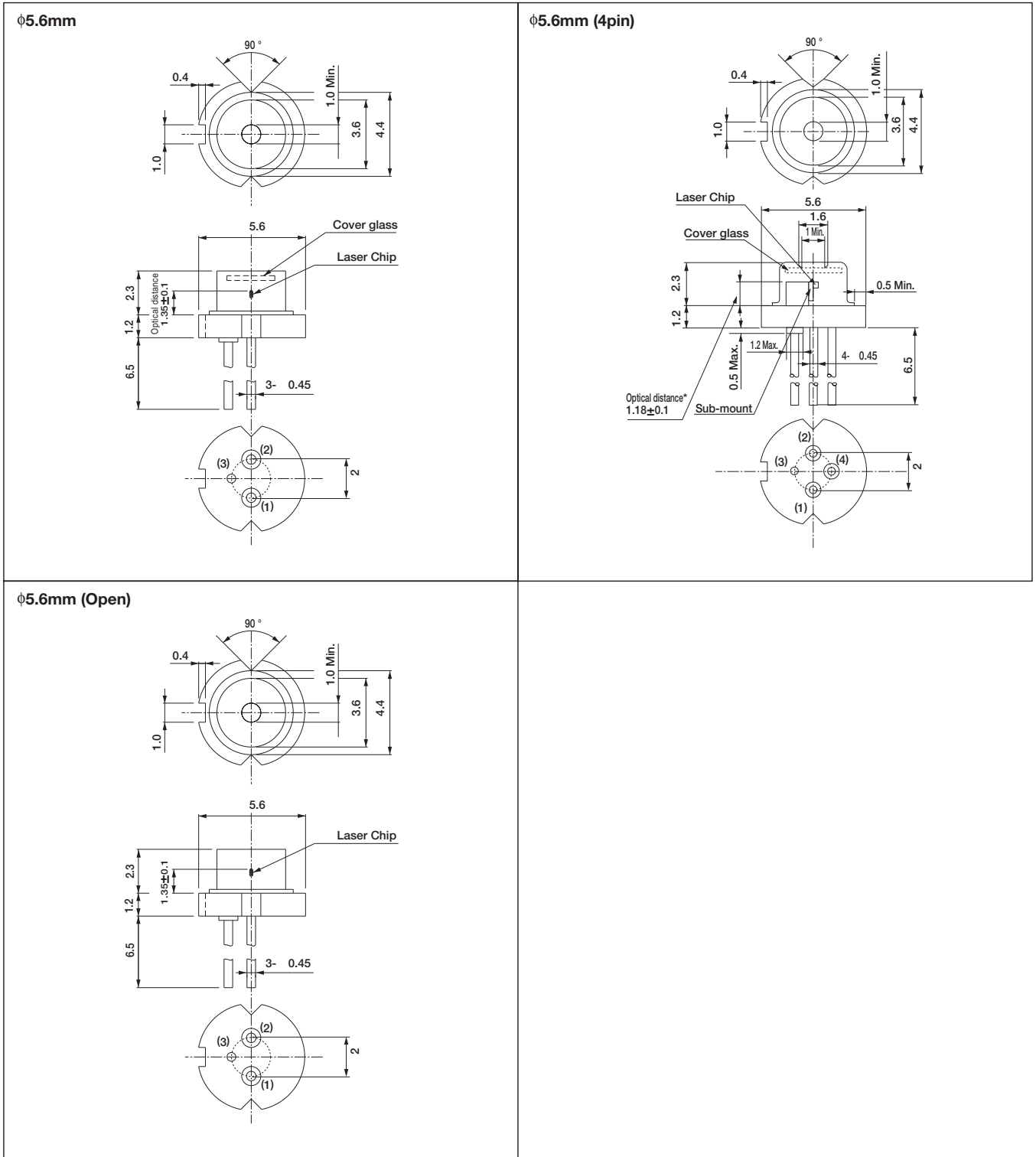

Fig.7 Emission Spectrum



Packaging Specifications

Dimensions (Unit: mm)



*Please note that differences may exist depending on the part number. Therefore, it is strongly recommended that the customer verify the actual specifications before usage.