

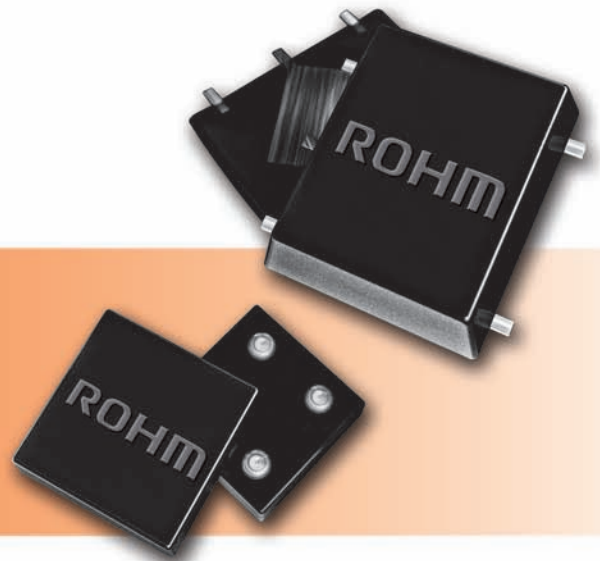

*Innovations Embedded*

Applications for  
Hall Effect IC Switches  
in Portable Applications



# Applications for Hall Effect IC Switches in Portable Electronics

19th century magnetic technology merged with 21st century ultra-small IC package innovation offers beneficial alternative to mechanical devices

---

According to the Semiconductor Industry Association, consumer electronics became the largest user and primary driver of semiconductors in 2004 and continues to increase over the corporate market segment. In consumer electronics, portable products are the fastest growing area. With cell phones alone projected to grow from over a billion units in 2007 to almost 1.5 billion in 2010 according to market research firm Gartner Dataquest, it should be no surprise.

While providing high volume opportunities for suppliers of the right components, consumer electronics and especially the portable consumer electronics portion places high demand on suppliers, requiring small size, high functionality, low power consumption and low cost as the major criteria for acceptance. In this highly competitive arena, the Hall effect, a magnetic technology discovered in the 19<sup>th</sup> century and popularized in the latter part of the 20<sup>th</sup> century through its implementation using large-scale integrated circuit (LSI) technology and advanced packaging is proving to be the right solution for adding functionality to cellular phones, portable computers, digital cameras, navigation systems, electronic toys and more.

In portable consumer electronic products, Hall effect sensors provide an effective alternative to mechanical switches with increased reliability as well as cost and/or performance advantages over other non-contact technologies. Using integrated bipolar sensing and CMOS logic circuitry with highly reliable semiconductor packaging and a small magnet, the Hall integrated circuit (IC) provides several useful functions.

## Applications in Portable Electronics

In consumer electronics, product acceptance is increasingly determined by:

- the user interface, where sensors provide awareness
- the overall user experience, where a subtle feature can become a wow factor.

The use of Hall effect IC switches are contributing to product acceptance in several of these applications.

### Open/Close Detection

Portable computers and flip or jack-knife style phones and other portable devices with a rotating hinge and clam shell design (see Figure 1) have historically used mechanical switches to indicate an open or closed position. Knowing whether the device is open or closed is essential for applying power to sleeping circuitry and returning to the sleep mode to conserve power.

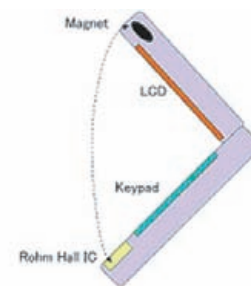
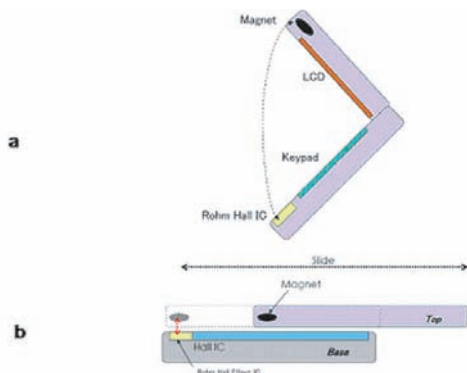

**Figure 1. Hall IC switch detects presence of magnet when the phone cover is closed**

The Hall effect IC switch detects the presence or absence of a magnetic field and outputs a digital signal for ON/OFF. In contrast to a mechanical switch with its potential wear-out mechanism, the Hall approach is a non-contact, long-life solution. In many cases, the

Hall effect switch can simplify the location of the sensor compared to a mechanical switch.

Some newer cell phones, digital cameras and other portable instruments use a sliding mechanism (Figure 2) where linear motion reveals the display or even a keyboard normally covered when the unit is in a standby mode. In this application, a Hall effect IC switch / magnet combination is commonly used.



**Figure 2. Hall IC switch detects presence of magnet when the phone cover is closed**

In these applications, the use of a Unipolar Hall effect IC is commonly used. Unipolar Hall IC switches only operate when a magnetic field of sufficient strength and polarity is detected. S-pole detecting devices are most common but N-pole detecting devices are also available. Hall effect IC switches capable of detecting a magnetic field of either polarity (Omnipolar) can also be used in this application. The unipolar devices typically require less power to operate but require the magnet to oriented properly while the omnipolar devices will operate without regard to magnet orientation.



**Figure 3. Polarity-discriminating Omnipolar Hall effect IC switches can be used to control the operation and orientation of multiple displays**

### Screen Orientation

In another variation, the screen pivots allowing the front or back face of the display to be viewed and the system has to discern which side of the display is facing the viewer. This application is also commonly found on PDAs, digital cameras, or tablet-style PCs. There are even some flat panel displays for desktop computers can rotate to view a portrait versus a landscape mode.

In these applications, it is necessary to use a Hall effect IC sensor, not only capable of detecting the magnetic field but also of discriminating the polarity of the field. (Figure 3)

Omnipolar Hall effect IC switches equipped with dual outputs make it possible to control screen orientation and other similar functions with a single device.

### Function Selection and Control

An increasingly important function in multi-function cell phones is the jog wheel or track ball (Figure 4), a human interface allowing the user to scroll through a list, increase or decrease the volume or implement another function. Some lower cost MP3 players use a jog wheel that moves clockwise or counterclockwise to select MP3 songs or scroll through a list of menu items.

Capacitive and even resistive touch sensing are also used for these applications, but the Hall effect sensor provides a lower cost solution.

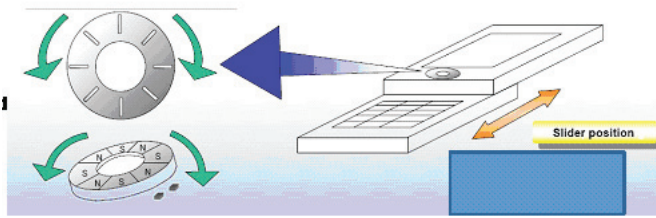

**Figure 4. Bipolar Hall IC switches detect the presence of alternating polarity magnetic fields to discern CW or CCW movement**

This application requires the use of two Bipolar, latching Hall ICs. The jog wheel has a series of alternating n-pole and s-pole oriented magnets. The two Hall ICs operating in combination are used to detect either clockwise or counterclockwise rotation of the wheel.

In more advanced applications in phones, computers and game handsets use a track ball that moves up and down and right and left. The design uses four Hall effect switches to determine the direction and how fast the ball is moving.

While mobile phones use Hall sensors for a variety of functions, some of these same applications can easily be found in [portable computers](#), [digital still cameras](#), [digital video cameras](#), [video game controllers](#), [navigation systems](#), [electronic toys](#) and more.

## Hall Effect Technology Basics

Current flowing in a conductor perpendicular to a magnet field causes a voltage, known as the Hall voltage on opposite sides of the conductor. While this has been known since 1879 when Edwin Hall discovered the phenomena, semiconductor technology has reduced the size of the Hall effect devices and added several key features that make Hall effect switches, sensors, and other products extremely useful in many applications. As shown in Figure 5, a magnetic field perpendicular to the plane of the semiconductor package, and the chip inside it, causes a low level Hall voltage. The Hall element is configured as a Wheatstone bridge, requiring additional circuitry including amplification and offset voltage compensation.

Design considerations for the various Hall effect sensing applications include magnetic strength and proximity of the magnet. For the smallest sensing system, neodymium magnets are recommended over ferrite magnets. A 4 x 4 mm neodymium magnet of 1 mm or 3 mm thickness operates with a separation of 7.66 mm to 10.4 mm between the magnet and the Hall IC. Increasing the detection distance requires increasing the thickness, sectional area or both.

For some cell phones, MR (magnetoresistive), GMR (giant magnetoresistive) or AMR (anisotropic magnetoresistive) sensing has also been used. The field direction is opposite to the Hall effect, which requires an orthogonal magnetic field. In general, the magnet strength needs to be about twice as large as a Hall effect device. However, prior to the introduction of chip scale packaging for Hall effect sensors, the MR packaging was smaller. With newer, smaller Hall effect ICs such as ROHM's products in the 1.1 x 1.1 x 0.5 mm chip scale package, the MR package size advantage has essentially disappeared especially since designers can save space and cost by using a smaller magnet.

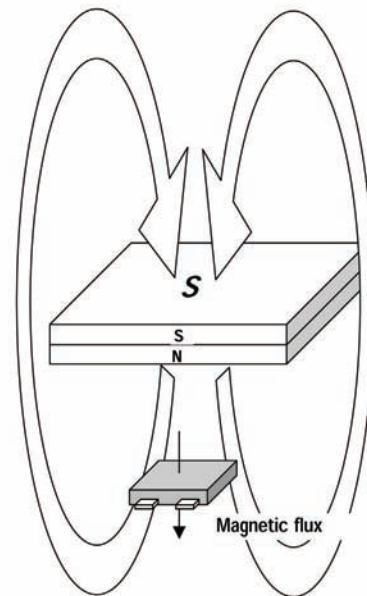

**Figure 5. A Hall voltage results from current flow in the semiconductor material when a magnet is located perpendicular to the flow**

## ROHM Hall Effect Technology

ROHM's Hall ICs use a single monolithic silicon chip with built in circuitry to provide additional functions and ease of interfacing. Also, instead of an analog output that is always on, ROHM pioneered the use of CMOS logic at the output to provide low power consumption. Today, all ROHM Hall effect switches use CMOS push-pull logic to provide a digital output that eliminates the need for an external pull up resistor required for the single FET output common in other Hall effect switches. The CMOS output interfaces directly to microcontrollers. Figure 6 shows the Hall effect element with the additional circuitry common to all ROHM Hall ICs that includes timing logic (SW), dynamic offset cancellation, amplification, sample and hold, comparator, oscillator, latch and the push-pull output. Some of ROHM's Hall sensors have two push-pull outputs for even greater functionality

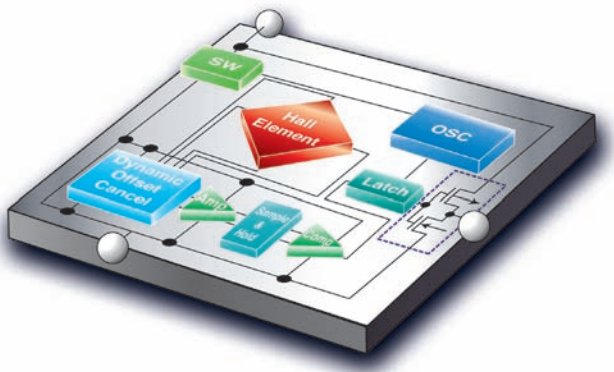

**Figure 6.** The block diagram of ROHM Hall effect shows the additional circuitry integrated with the Hall sensor that makes it easy to interface in sensing applications.

Sample and hold circuitry reduces power consumption for power conscious battery-powered applications. ROHM's Hall ICs typically have a sampling period of 50 milliseconds. As shown in Figure 7, the device wakes up for a 48  $\mu$ s sample of the magnetic field and then returns to sleep. As a result, the typical operating current is only 8  $\mu$ A for 2.7V applications and an even lower 5  $\mu$ A for 1.8V operation. Since ROHM Hall ICs were designed for battery powered applications, they can operate from voltages as low as 1.65 to 3.3V. The bipolar Hall ICs

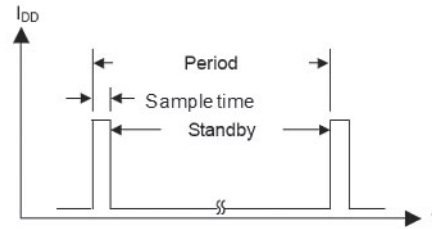

**Figure 7.** The typical sample time of 48  $\mu$ s for each 50 ms period reduces the average current draw to 8  $\mu$ A or even 5  $\mu$ A.

designed for jog wheel or track ball applications have a much faster sampling period (0.5 ms).

The design of the sensing element and circuitry in ROHM Hall effect ICs ensures high electrostatic discharge (ESD) tolerance with ratings of up to 8 kV as measured in the human body model (HBM). Operating over a temperature range of -40°C to 85°C, the monolithic silicon Hall sensor has a high level of magnetic flux density detection stability versus temperature. In addition, many models have a high sensitivity with typical operating point of 3.7 mT (3.0 mT on ICs designed for 1.8V operation). Dynamic offset cancellation eliminates the differential in the Hall element Wheatstone bridge for improved accuracy and a hysteresis comparator increases the noise resistance.

With a mounting area of 1.1 x 1.1 x 0.5 mm, ROHM's VCSP5OL1 chip scale package (CSP) provides the smallest Hall effect sensor for the most demanding, space limited applications. The image below shows the CSP compared the HVSO5 surface-mount (SMT) package.



**Figure 8.** ROHM Hall ICs are offered in the surface-mount HVSO5 package with a footprint of just 1.6 x 1.6 mm and in the even smaller VCSP5OL1 1.1 mm square, chip scale package.

## ROHM Hall Effect Topologies

To provide the right sensor for a variety of applications, [ROHM Hall ICs](#) are available in four different designs as shown in Figures 9a – 9d.

Unipolar devices only detect the presence of a specific polarity magnetic field. Competing Hall IC vendors typically offer this type of device for S-pole sensing only.

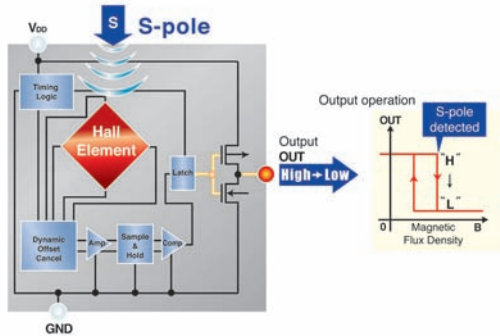

Figure 9a. ROHM Unipolar Hall IC topology shown for S-Pole Detection

ROHM offers both N-pole and S-pole versions. Unipolar devices offer the highest energy savings but require extra care in proper polarity placement of the magnet.

Omnipolar Hall ICs detect both magnetic poles, eliminating the need to mark the magnet's surface.

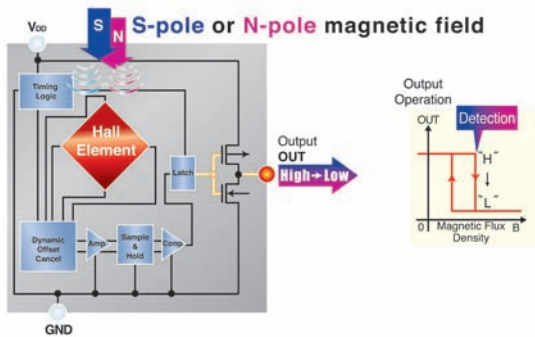

Figure 9b. ROHM Omnipolar Hall IC topology detects either N or S-pole

Polarity Discriminating (Omnipolar) Hall sensors have dual outputs and discern N- and S-poles so position and orientation can be detected.

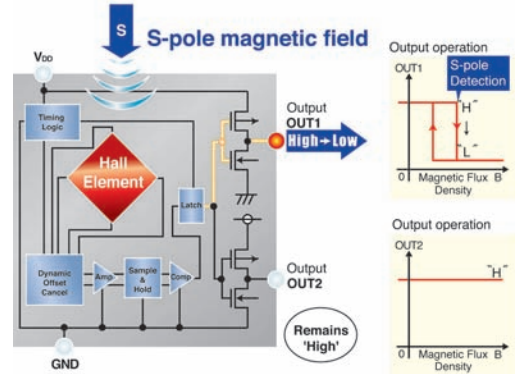

Figure 9c. ROHM Polarity-Discriminating Omnipolar Hall IC Switches have dual outputs

Bipolar (latching) operation Hall devices detect alternating poles but do not change state if a pole is not detected. The newest bipolar design, the [BU52040HFV](#), has a 0.5 ms response time, about 100 times faster than other ROHM Hall sensors, to meet the requirements of jog wheel applications on digital cameras, mobile phones, PDAs or MP3 players.

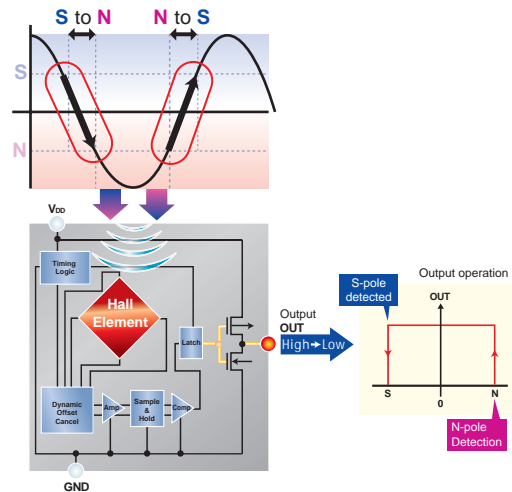

Figure 9d. ROHM Bipolar Hall IC changes state only when magnetic polarity is reversed

## Hall Effect in Future Products

While portable consumer electronic products represent a rapidly growing market for Hall effect switches, it is just one segment which can benefit from the technology. Similar functions are frequently required in the [white goods industry](#), especially for the door open/shut indication. Even automobiles can take advantage of the non-contacting sensing in applications such as steering wheel position/rotation. While products for these applications must meet different specifications including higher voltage operation than consumer products, they are among the planned additions to ROHM's product portfolio. Ultimately, several industries will benefit from the use of small but sensitive Hall effect ICs.

## Other ROHM Products in Portable Electronics

In addition to Hall IC switches, ROHM has an extensive portfolio of products filling many of the "sockets" in portable electronics devices. For a complete view of ROHM's product portfolio, application-by-application, visit

<http://www.rohm.com/products/application/index.html>

To get more details on the complete line of ROHM Hall effect IC switches, visit:

[www.rohmsemiconductor.com/Hall\\_ICs.html](http://www.rohmsemiconductor.com/Hall_ICs.html)

At this site you will find a comprehensive product selection guide, product datasheets and additional application information.



## **ROHM** SEMICONDUCTOR

10145 Pacific Heights Blvd., Suite 1000  
San Diego, CA 92121

[www.rohmsemiconductor.com](http://www.rohmsemiconductor.com) | 1.888.775.ROHM



NOTE: For the most current product information, contact a ROHM sales representative in your area.

ROHM assumes no responsibility for the use of any circuits described herein, conveys no license under any patent or other right, and makes no representations that the circuits are free from patent infringement. Specifications subject to change without notice for the purpose of improvement.

The products listed in this catalog are designed to be used with ordinary electronic equipment or devices (such as audio visual equipment, office-automation equipment, communications devices, electrical appliances and electronic toys). Should you intend to use these products with equipment or devices which require an extremely high level of reliability and the malfunction of which would directly endanger human life (such as medical instruments, transportation equipment, aerospace machinery, nuclear-reactor controllers, fuel controllers and other safety devices), please be sure to consult with our sales representative in advance.

© 2009 ROHM Semiconductor USA, LLC. Although every effort has been made to ensure accuracy, ROHM accepts no responsibility for errors or omissions. Specifications and product availability may be revised without notice. No part of this document represents an offer or contract. Industry part numbers, where specified, are given as an approximate comparative guide to circuit function only. Consult ROHM prior to use of components in safety, health or life-critical systems. All trademarks acknowledged.