

Ambient Light Sensor IC Series

Analog Current Output Type Ambient Light Sensor IC

BH1600FVC

No.09046EAT04

● Descriptions

BH1600FVC is an analog current output ambient light sensor. BH1600FVC is the most suitable to obtain the ambient light data for adjusting LCD and Keypad backlight of Mobile phone for power saving and better visibility

● Features

- 1) Compact surface mount package 3.0 × 1.6 mm
- 2) Spectral sensitivity close to human eyes sensitivity.
- 3) Output current in proportion to brightness.
- 4) Minimum supply voltage 2.4V
- 5) Built-in shutdown function
- 6) 2 steps controllable output current gain.
- 7) 1.8V logic input interface

● Applications

Mobile phone, LCD TV, PDP TV, Laptop PC, Portable game console, Digital camera, Digital video camera, Car navigation, PDA, LCD display

● Absolute Maximum Ratings

Parameter	Symbol	Limits	Units
Supply Voltage	Vmax	4.5	V
Operating Temperature	Topr	-30~85	°C
Storage Temperature	Tstg	-40~100	°C
Output Current	Ioutmax	7.5	mA
Power Dissipation	Pd	260*	mW

* 70mm × 70mm × 1.6mm glass epoxy board. Derating at 3.47mW/°C for operating above Ta=25°C.

● Operating Conditions

Parameter	Symbol	Min.	Typ.	Max.	Units
Vcc Voltage	Vcc	2.4	3.0	3.6	V

● Electrical Characteristics (Vcc = 3.0V, Ta = 25°C, unless otherwise noted)

Parameter	Symbol	Min.	Typ.	Max.	Units	Conditions
Supply Current	Icc1	39	64	90	μA	Ev=100 lx (H-Gain Mode) *
Shutdown Current	Icc2sd	-	0.01	0.2	μA	VGC1=VGC2=0 No Input Light
Dark Current	Idark	-	-	0.1	μA	Ev=0 lx
Light Current	Iout	39	60	81	μA	Ev=100 lx (H-Gain Mode) *
Peak Wave Length	λp	-	560	-	nm	
Incandescent/Fluorescent Light Current Ratio	rIF	-	1.0	-	times	Ev=100 lx
Saturated Output Voltage	Vomax	2.6	2.9	3.0	V	Ev=100 lx, RL=220kΩ (H-Gain Mode) *
GC1, GC2 Input 'L' Voltage	VIL	0	-	0.4	V	
GC1,GC2 Input 'H' Voltage	VIH	1.4	-	Vcc	V	
Wake-up Time	twu	-	64	128	μs	Shutdown → H-Gain Mode Ev=100lx *
Gain Ratio H-Gain Mode / L-Gain Mode		-	9.5	10	times	Ev=100 lx *

* White LED is used as optical source

●Reference Data

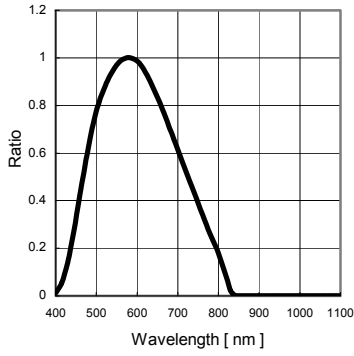

Fig.1 Spectral Response

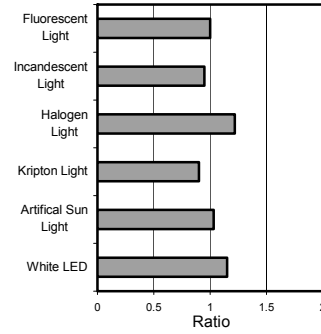

Fig.2 Light Source Dependency (Fluorescent Light is set to '1')

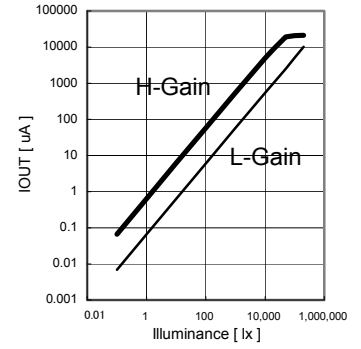

Fig.3 Illuminance – IOUT Characteristics

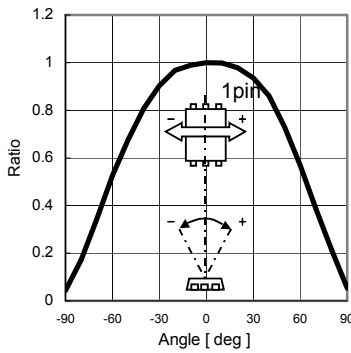

Fig.4 Directional Characteristics 1

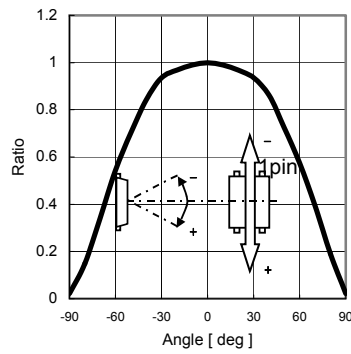

Fig.5 Directional Characteristics 2

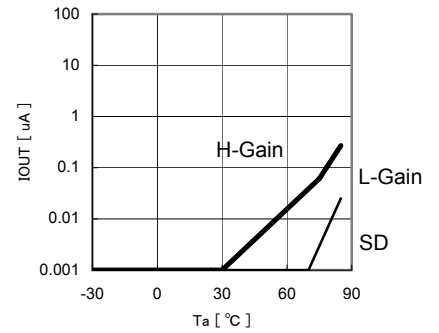

Fig.6 Ta – IOUT (0 lx)

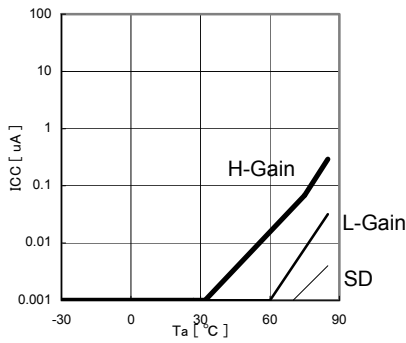

Fig.7 Ta – Icc (0 lx)

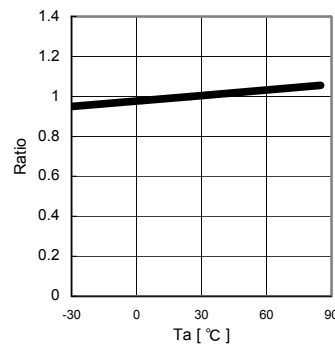

Fig.8 IOUT Temperature dependency(100 lx)

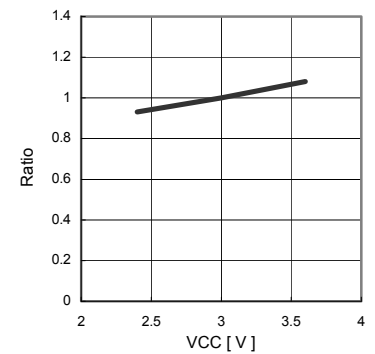

Fig.9 IOUT Vcc dependency

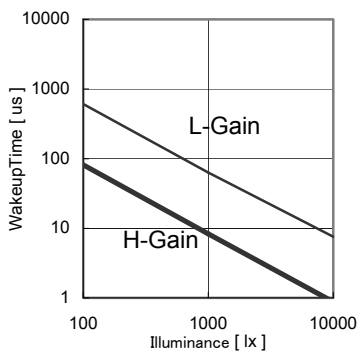
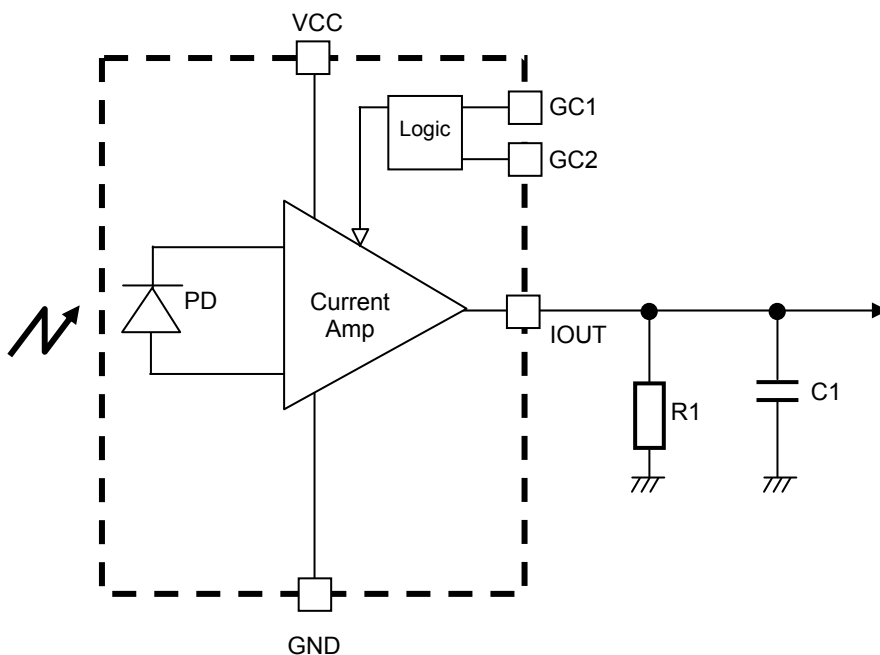

Fig.10 Illuminance – Wake up Time

●Block Diagram



●Block Diagram Descriptions

- PD
Photo diode close to human eyes sensitivity.
- Current AMP
To amplify Photo diode current (H-Gain / L-Gain)
Gain controllable in 2 steps by input voltage from GC1 and GC2.
- Logic
Logic block for mode setting by input voltage from GC1 and GC2

●Mode Setting

GC2	GC1	Mode
0	0	Shutdown
0	1	H-Gain Mode
1	0	L-Gain Mode
1	1	Test Mode (Input prohibition)

●External parts Setting

1) Gain setting of BH1600FVC

Please select the best gain controlled by 5 and 6pin based on the required illuminance range.
The reference is as follows.

Illuminance detection range [lx]	Gain Mode
~ 500	H-Gain Mode
~50000	L-Gain Mode

This device will be mounted under the optical window in actual designing. Therefore, there is a possibility that the illuminance to ALS(Ambient Light Sensor) will be less than the illuminance on the final product surface.
Please consider the attenuation of light through the optical window.

It is possible to detect illuminance up to about 5000 lx even in the H-Gain mode. However, the maximum output current is about 3mA in this case. If you want to minimize consumption current, please use the L-Gain mode as much as possible.
Please set output resistance value(R1) within the range of 1 kΩ ~ 1MΩ which needs to be smaller than the input impedance of the next circuit.

2) Approximate formula of IOUT output voltage in each Gain Mode

(1) H-Gain mode

The output voltage is calculated as below.

$$V_{iout} = 0.6 \times 10^{-6} \times E_v \times R_1$$

V_{iout} is IOUT output voltage [V]. E_v is an illuminance of the ALS surface [lx].

R_1 is IOUT output resistor[Ω].

(For example) In case you want to convert the illuminance value up to 500 lx by ADC.

If the maximum voltage of ADC input is 2V, output resistor value will be as below.

$$\begin{aligned} R_1 &= V_{iout} / (0.6 \times 10^{-6} \times E_v) \\ &= 2 / (0.6 \times 10^{-6} \times 500) = 6667[\Omega] \\ &\Rightarrow 6.8[k\Omega] \end{aligned}$$

(2) L-Gain mode

The output voltage is calculated as follows.

$$V_{iout} = 0.063 \times 10^{-6} \times E_v \times R_1$$

3)C1

In case IOUT output is R1 only and an ALS receives the artificial lights such as fluorescent lamps and incandescent lamps synchronized with 50/60 Hz of AC power supplies, the output current has a ripple. Therefore, please add C1 to R1 in parallel if necessary.

When you control back light by using illuminance value, C1 is effective to control smoothly for a rapid changing of the illuminance. In general, please set it to $C1 \times R1 =$ about 1~10 as a time constant. In this case, the rise time becomes slow at power-on and recovery from shutdown mode to operation mode.

● Terminal Descriptions

Pin No.	Pin Name	Equivalent Circuit	Function
1	IOUT		<p>This terminal outputs current depending on illuminance level. Use this pin by putting resistor between GND.</p>
2	GND		GND Terminal
3	VCC		Power Supply Terminal
4	NC		NC(Non connection)Terminal Open or short to GND
5	GC1		Mode Setting Terminal 1
6	GC2		Mode Setting Terminal 2

●Package Outlines

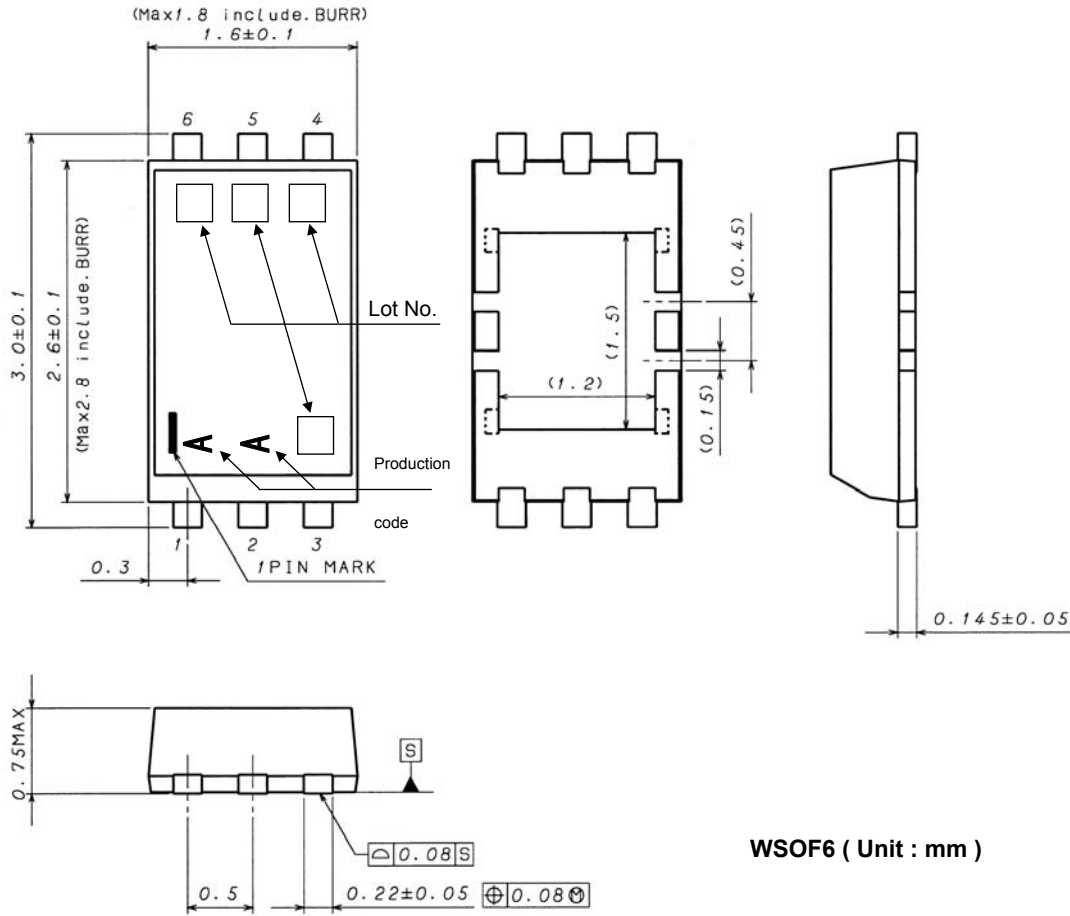

WSOF6 (Unit : mm)

●Optical design for the device

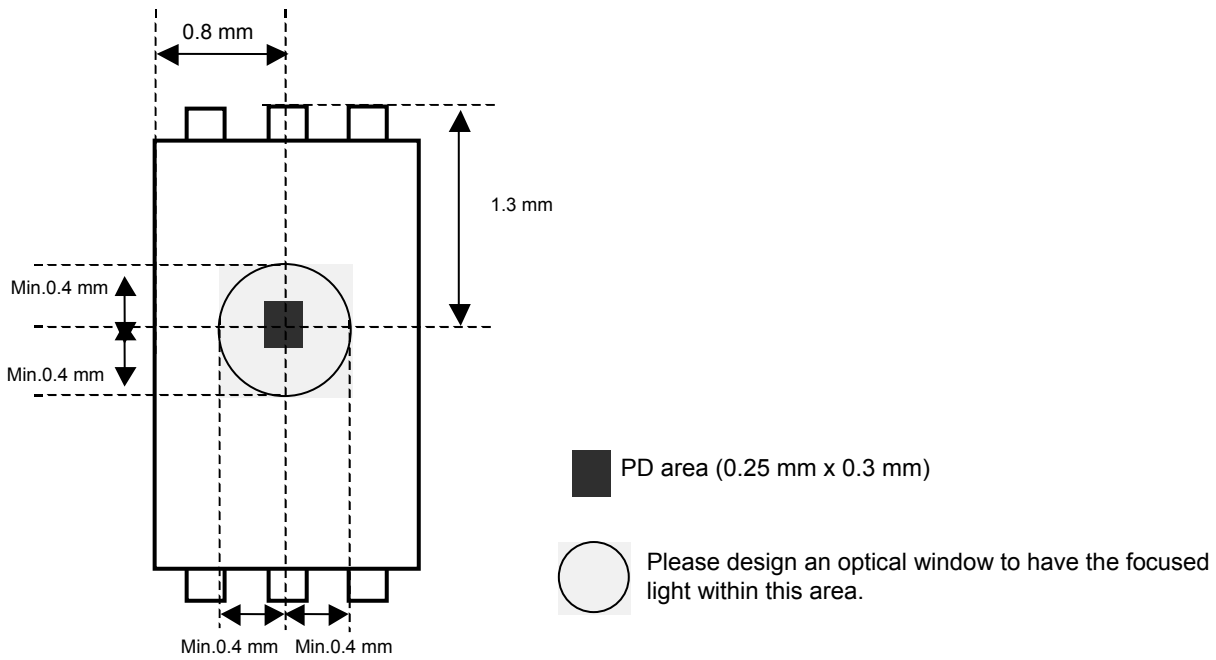

●Notes for use

1) Absolute Maximum Ratings

An excess in the absolute maximum ratings, such as supply voltage (V_{max}), temperature range of operating conditions (T_{opr}), etc., can break down devices, thus making impossible to identify breaking mode such as a short circuit or an open circuit. If any special mode exceeding the absolute maximum ratings is assumed, consideration should be given to take physical safety measures including the use of fuses, etc.

2) GND voltage

Make setting of the potential of the GND terminal so that it will be maintained at the minimum in any operating state. Furthermore, check to be sure no terminals are at a potential lower than the GND voltage including an actual electric transient.

3) Short circuit between terminals and erroneous mounting

In order to mount ICs on a set PCB, pay thorough attention to the direction and offset of the ICs. Erroneous mounting can break down the ICs. Furthermore, if a short circuit occurs due to foreign matters entering between terminals or between the terminal and the power supply or the GND terminal, the ICs can break down.

4) Operation in strong electromagnetic field

Be noted that using ICs in the strong electromagnetic field can malfunction them.

5) Inspection with set PCB

On the inspection with the set PCB, if a capacitor is connected to a low-impedance IC terminal, the IC can suffer stress. Therefore, be sure to discharge from the set PCB by each process. Furthermore, in order to mount or dismount the set PCB to/from the jig for the inspection process, be sure to turn OFF the power supply and then mount the set PCB to the jig. After the completion of the inspection, be sure to turn OFF the power supply and then dismount it from the jig. In addition, for protection against static electricity, establish a ground for the assembly process and pay thorough attention to the transportation and the storage of the set PCB.

6) Input terminals

In terms of the construction of IC, parasitic elements are inevitably formed in relation to potential. The operation of the parasitic element can cause interference with circuit operation, thus resulting in a malfunction and then breakdown of the input terminal. Therefore, pay thorough attention not to handle the input terminals; such as to apply to the input terminals a voltage lower than the GND respectively, so that any parasitic element will operate. Furthermore, do not apply a voltage to the input terminals when no power supply voltage is applied to the IC. In addition, even if the power supply voltage is applied, apply to the input terminals a voltage lower than the power supply voltage or within the guaranteed value of electrical characteristics.

7) Thermal design

Perform thermal design in which there are adequate margins by taking into account the permissible dissipation (pd) in actual states of use.

8) Treatment of package

Dusts or scratch on the photo detector may affect the optical characteristics. Please handle it with care.

9) Rush current

When power is first supplied to this IC, rush current may flow instantaneously. Because it is possible that the charge current to the parasitic capacitance of internal photo diode or the internal logic may be unstable.

Therefore, give special consideration to power coupling capacitance, power wiring, width of GND wiring, and routing of connections.

10) The exposed central pad on the back side of the package

There is an exposed central pad on the back side of the package. But please do it non connection. (Don't solder, and don't do electrical connection) Please mount by Footprint dimensions described in the Jisso Information for WSOF6. This pad is GND level, therefore there is a possibility that LSI malfunctions and heavy-current is generated.

●Ordering part number

B	H
---	---

Part No.

1	6	0	0
---	---	---	---

Part No.
1600

F	V	C
---	---	---

Package
FVC: WSOF6

T	R
---	---

Packaging and forming specification
TR: Embossed tape and reel
(WSOF6)

WSOF6

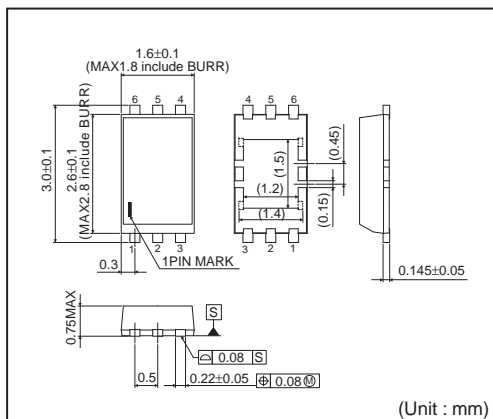

<Tape and Reel information>

Tape	Embossed carrier tape
Quantity	3000pcs
Direction of feed	TR (The direction is the 1pin of product is at the upper right when you hold reel on the left hand and you pull out the tape on the right hand)

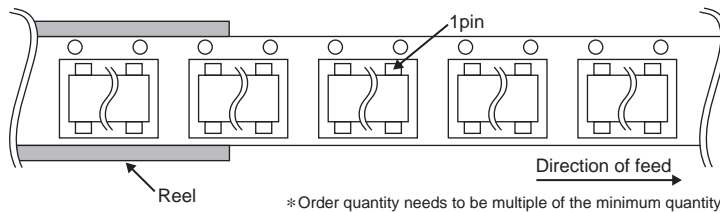

Notes

No copying or reproduction of this document, in part or in whole, is permitted without the consent of ROHM Co.,Ltd.

The content specified herein is subject to change for improvement without notice.

The content specified herein is for the purpose of introducing ROHM's products (hereinafter "Products"). If you wish to use any such Product, please be sure to refer to the specifications, which can be obtained from ROHM upon request.

Examples of application circuits, circuit constants and any other information contained herein illustrate the standard usage and operations of the Products. The peripheral conditions must be taken into account when designing circuits for mass production.

Great care was taken in ensuring the accuracy of the information specified in this document. However, should you incur any damage arising from any inaccuracy or misprint of such information, ROHM shall bear no responsibility for such damage.

The technical information specified herein is intended only to show the typical functions of and examples of application circuits for the Products. ROHM does not grant you, explicitly or implicitly, any license to use or exercise intellectual property or other rights held by ROHM and other parties. ROHM shall bear no responsibility whatsoever for any dispute arising from the use of such technical information.

The Products specified in this document are intended to be used with general-use electronic equipment or devices (such as audio visual equipment, office-automation equipment, communication devices, electronic appliances and amusement devices).

The Products specified in this document are not designed to be radiation tolerant.

While ROHM always makes efforts to enhance the quality and reliability of its Products, a Product may fail or malfunction for a variety of reasons.

Please be sure to implement in your equipment using the Products safety measures to guard against the possibility of physical injury, fire or any other damage caused in the event of the failure of any Product, such as derating, redundancy, fire control and fail-safe designs. ROHM shall bear no responsibility whatsoever for your use of any Product outside of the prescribed scope or not in accordance with the instruction manual.

The Products are not designed or manufactured to be used with any equipment, device or system which requires an extremely high level of reliability the failure or malfunction of which may result in a direct threat to human life or create a risk of human injury (such as a medical instrument, transportation equipment, aerospace machinery, nuclear-reactor controller, fuel-controller or other safety device). ROHM shall bear no responsibility in any way for use of any of the Products for the above special purposes. If a Product is intended to be used for any such special purpose, please contact a ROHM sales representative before purchasing.

If you intend to export or ship overseas any Product or technology specified herein that may be controlled under the Foreign Exchange and the Foreign Trade Law, you will be required to obtain a license or permit under the Law.



Thank you for your accessing to ROHM product informations.
More detail product informations and catalogs are available, please contact us.

ROHM Customer Support System

<http://www.rohm.com/contact/>