

Secondary LDO Regulators for Local Power Sources

Fixed/Variable Dual-output Secondary LDO Regulators BA3259HFP, BA30E00WHFP



●Description

The BA3259HFP and BA30E00WHFP are 2-output, low-saturation regulators. These units have both a 3.3 V fixed output as well as a variable output with a voltage accuracy of $\pm 2\%$, and incorporate an overcurrent protection circuit to prevent IC destruction due to output shorting along with a TSD (Thermal Shut Down) circuit to protect the IC from thermal destruction caused by overloading.

●Features

- 1) Output voltage accuracy: $\pm 2\%$.
- 2) Reference voltage accuracy: $\pm 2\%$
- 3) Output current capacity: 1 A (BA3259HFP), 0.6 A (BA30E00WHFP)
- 4) Ceramic capacitor can be used to prevent output oscillation (BA3259HFP)
- 6) Low dissipation with two voltage input supported (BA30E00WHFP)
- 7) Built-in thermal shutdown circuit
- 8) Built-in overcurrent protection circuit

●Applications

Available to all commercial devices, such as FPD, TV, and PC sets besides DSP power supplies for DVD and CD sets.

●Product Lineup

Part Number	Output voltage Vo1	Output voltage Vo2	Output Current Io1	Output Current Io2	Package
BA3259HFP	3.3 V	0.8 V to 3.3 V	1 A max	1 A max	HRP-5
BA30E00WHFP	3.3 V	0.8 V to 3.3 V	0.6 A max	0.6 A max	HRP-7

●Absolute Maximum Ratings

BA3259HFP

Parameter	Symbol	Limit	Units
Applied voltage	Vcc	15 *1	V
Power dissipation	Pd	2300 *2	mW
Operating temperature range	Topr	0 to 85	°C
Ambient storage temperature range	Tstg	-55 to 150	°C
Maximum junction temperature	Tjmax	150	°C

BA30E00WHFP

Parameter	Symbol	Limit	Units
Applied voltage	Vcc	18 *1	V
Power dissipation	Pd	2300 *2	mW
Operating temperature range	Topr	-25 to 105	°C
Ambient storage temperature range	Tstg	-55 to 150	°C
Maximum junction temperature	Tjmax	150	°C

*1 Must not exceed Pd.

*2 Derated at 18.4 mW/°C at Ta>25°C when mounted on a glass epoxy board (70 mm × 70 mm × 1.6 mm).

●Recommended Operating Conditions

BA3259HFP

Parameter	Symbol	Min.	Typ.	Max.	Unit
Input power supply voltage	Vcc	4.75	-	14.0	V
3.3 V output current	Io1	-	-	1	A
Variable output current	Io2	-	-	1	A

BA30E00WHFP

Parameter	Symbol	Min.	Typ.	Max.	Unit
Input power supply voltage 1	Vcc1	4.1	-	16.0	V
Input power supply voltage 2	Vcc2	2.8	-	Vcc1	V
3.3 V output current	Io1	-	-	0.6	A
Variable output current	Io2	-	-	0.6	A

●Electrical Characteristics

BA3259HFP (Unless otherwise specified, Ta = 25°C, Vcc = 5 V, R1 = R2 = 5 kΩ)

Parameter	Symbol	Min.	Typ.	Max.	Unit	Conditions
Circuit current	IB	-	3	5	mA	Io1 = 0 mA, Io2 = 0 mA
[3.3 V Output Block]						
Output voltage 1	Vo1	3.234	3.300	3.366	V	Io1 = 50 mA
Minimum I/O voltage difference 1	ΔVd1	-	1.1	1.3	V	Io1 = 1 A, Vcc = 3.8 V
Current capability 1	Io1	1.0	-	-	A	
Ripple rejection 1	R.R.1	46	52	-	dB	f = 120 Hz, ein = 0.5 Vp-p, Io1 = 5 mA
Input stability 1	ΔVLINE1	-	5	15	mV	Vcc = 4.75 → 14 V, Io1 = 5 mA
Load stability 1	ΔVLOAD1	-	5	20	mV	Io1 = 5 mA → 1 A
Temperature coefficient of output voltage 1 ^{*3}	Tcvo1	-	±0.01	-	%/°C	Io1 = 5 mA, Tj = 0°C to 85°C
[Variable output]						
Reference voltage	VREF	0.784	0.800	0.816	V	Io2 = 50 mA
Minimum I/O voltage difference 2	ΔVd2	-	1.1	1.3	V	Io2 = 1 A
Current capability 2	Io2	1.0	-	-	A	
Ripple rejection 2	R.R.2	46	52	-	dB	f = 120 Hz, ein = 0.5 Vp-p, Io2 = 5 mA
Input stability 2	ΔVLINE2	-	5	15	mV	Vcc = 4.75 → 14 V, Io2 = 5 mA
Load stability 2	ΔVLOAD2	-	5	20	mV	Io2 = 5 mA → 1 A
Temperature coefficient of output voltage 2 ^{*3}	Tcvo2	-	±0.01	-	%/°C	Io2 = 5 mA, Tj = 0°C to 85°C
Variable pin current	IADJ	-	0.05	1.0	μA	VADJ = 0.85 V

*3: Operation is guaranteed within these parameters

BA30E00WHFP (Unless otherwise specified, Ta = 25°C, Vcc1 = Vcc2 = VEN = 5 V, R1 = 50 kΩ, R2 = 62.5 kΩ)

Parameter	Symbol	Min.	Typ.	Max.	Unit	Conditions
Bias current	Ib	-	0.7	1.6	mA	Io1 = 0 mA, Io2 = 0 mA
Standby current	IST	-	0	10	μA	VEN = GND
EN pin on voltage	VON	2.0	-	-	V	Active mode
EN pin off voltage	VOFF	-	-	0.8	V	Standby mode
EN pin current	IEN	-	50	100	μA	VEN = 3.3 V
[3.3 V output]						
Output voltage 1	Vo1	3.234	3.300	3.366	V	Io1 = 50 mA
Minimum I/O voltage difference 1	ΔVd1	-	0.30	0.60	V	Io1 = 300 mA, Vcc = 3.135 V
Output current capacity 1	Io1	0.6	-	-	A	
Ripple rejection 1	R.R.1	-	68	-	dB	f = 120 Hz, ein = 1 Vp-p, Io1 = 100 mA
Input stability 1	Reg.I1	-	5	30	mV	Vcc1 = 4.1 → 16 V, Io1 = 50 mA
Load stability 1-1	Reg.L1-1	-	30	90	mV	Io1 = 0 mA → 0.6 A
Load stability 1-2	Reg.L1-2	-	30	90	mV	Vcc1 = 3.7 V, Io1 = 0 → 0.4 A
Temperature coefficient of output voltage 1 ^{*3}	Tcvo1	-	±0.01	-	%/°C	Io1 = 5 mA, Tj = 0°C to 125°C
[Variable output] (at 1.8 V)						
Reference voltage	VADJ	0.784	0.800	0.816	V	Io2 = 50 mA
Minimum I/O voltage difference 2	ΔVd2	-	0.30	0.60	V	At Io2 = 3.3 V Io2 = 300 mA, Vcc1 = Vcc2 = 3.135 V
Output current capacity 2	Io2	0.6	-	-	A	
Ripple rejection 2	R.R.2	-	66	-	dB	f = 120 Hz, ein = 1 Vp-p, Io2 = 100 mA
Input stability 2	Reg.I2	-	5	30	mV	Vcc1 = Vcc2 = 4.1 V → 16 V, Io2 = 50 mA
Load stability 2	Reg.L2	-	30	90	mV	Io2 = 0 mA → 0.6 A
Temperature coefficient of output voltage 2 ^{*3}	Tcvo2	-	±0.01	-	%/°C	Io2 = 5 mA, Tj = 0°C to 125°C

*3: Operation is guaranteed within these parameters

●BA3259HFP Electrical Characteristics Curves (Unless otherwise specified, $T_a = 25^\circ\text{C}$, $V_{cc} = 5\text{ V}$)

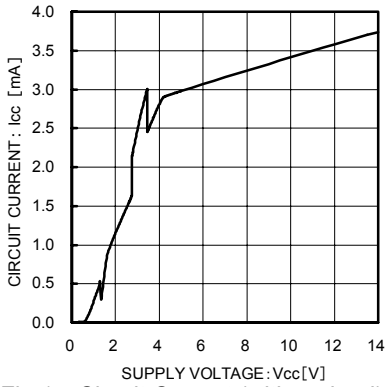

Fig.1 Circuit Current (with no load)

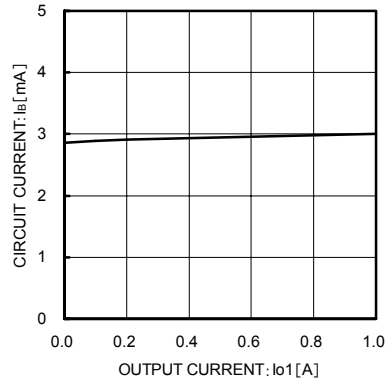

Fig.2 Circuit Current vs Load Current I_o

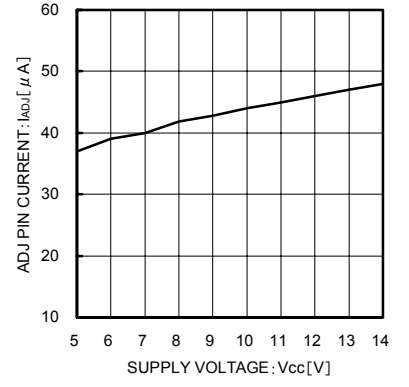

Fig.3 ADJ Pin Outflow Current

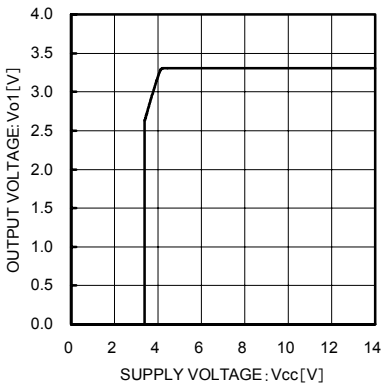

Fig.4 Input Stability
(3.3 V output with no load)

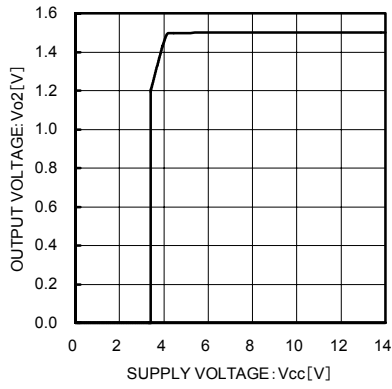

Fig.5 Input Stability
(Variable output with no load)

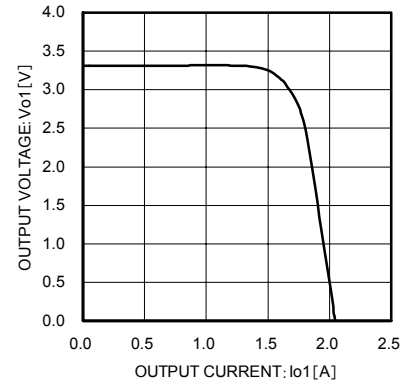

Fig.6 Load Stability
(3.3 V output)

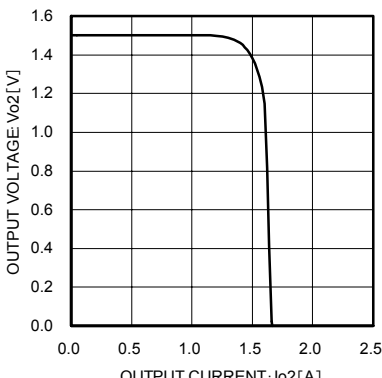

Fig.7 Load Stability
(Variable output: 1.5 V)

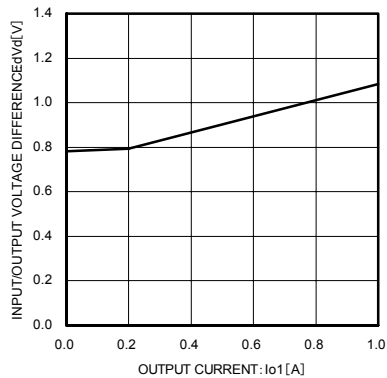

Fig.8 I/O Voltage Difference (3.3 V output)
(3.3 V output, I_{o1} = 0 A → 1 A)

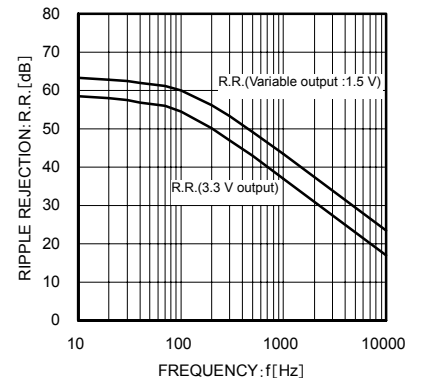

Fig.9 R.R.

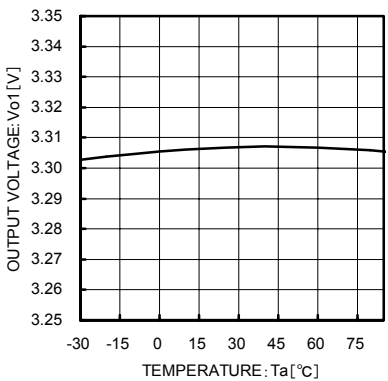

Fig.10 Output Voltage vs Temperature
(3.3 V output)

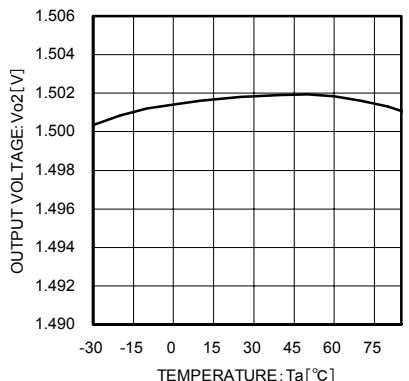

Fig.11 Output Voltage vs Temperature
(Variable output: 1.5 V)

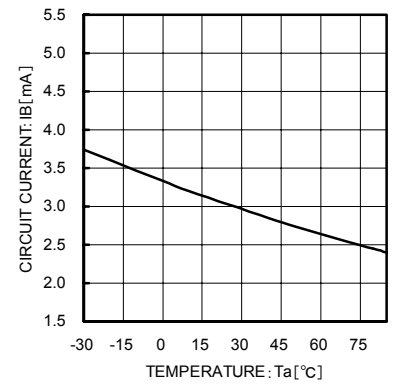

Fig.12 Circuit Current vs Temperature

●BA30E00WHFP Electrical Characteristics Curves (Unless otherwise specified, $T_a = 25^\circ\text{C}$, $V_{cc1} = V_{cc2} = 5\text{V}$)

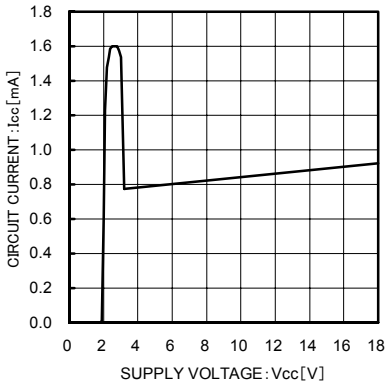

Fig. 13 Circuit Current (with no load)

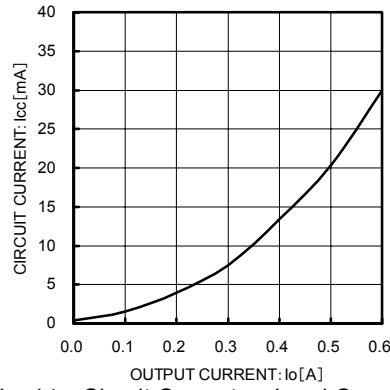

Fig. 14 Circuit Current vs Load Current I_o ($I_o = 0 \rightarrow 600\text{ mA}$)

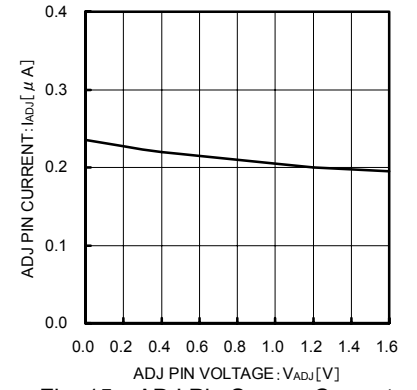

Fig. 15 ADJ Pin Source Current

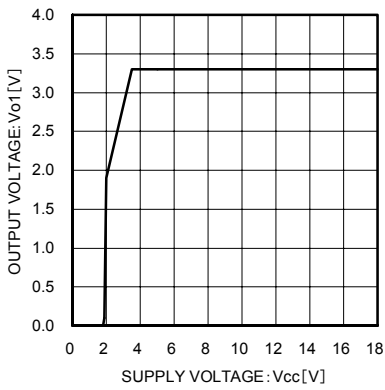

Fig. 16 Input Stability
(3.3 V output $I_{o1} = 600\text{ mA}$)

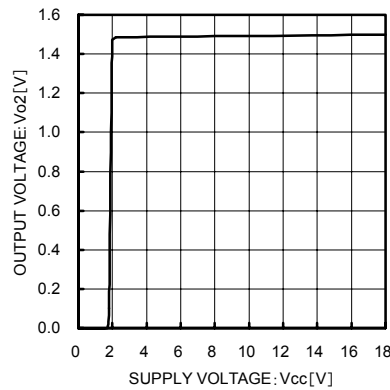

Fig. 17 Input Stability
(Variable output: 1.8 V)

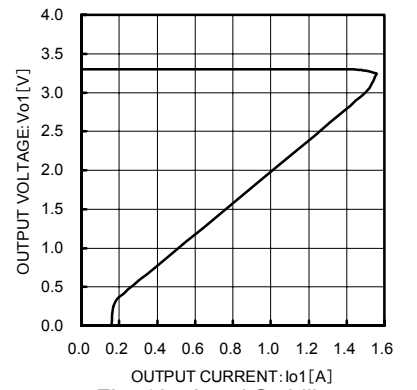

Fig. 18 Load Stability
(3.3 V output)

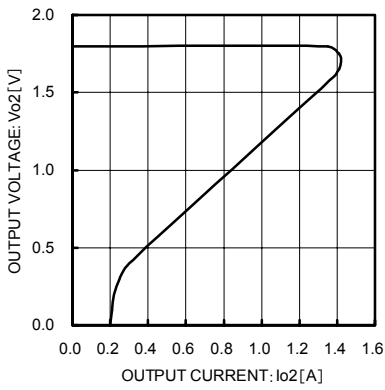

Fig. 19 Load Stability
(Variable output: 1.8 V)

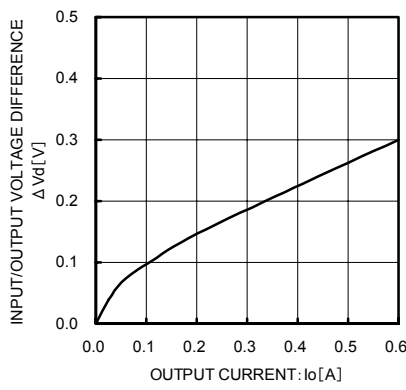

Fig. 20 I/O Voltage Difference
($V_{cc} = 3.135\text{ V}$, 3.3 V output)

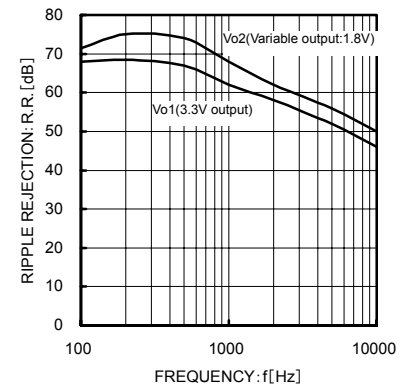

Fig. 21 R.R.
($e_{in} = 1\text{ V}_{p-p}$, $I_o = 100\text{ mA}$)

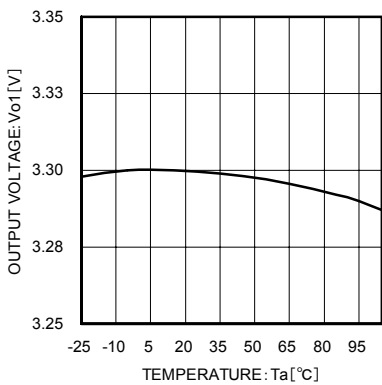

Fig. 22 Output Voltage vs Temperature
(3.3 V output)

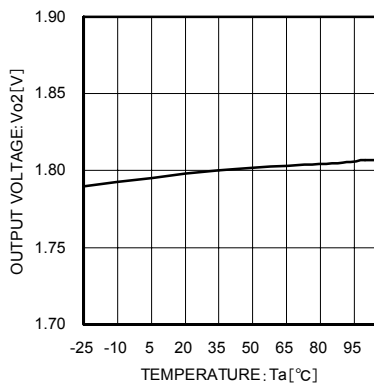

Fig. 23 Output Voltage vs Temperature
(Variable output: 1.8 V)

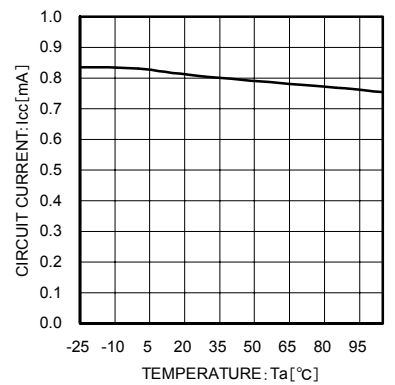

Fig. 24 Circuit Current vs Temperature
($I_o = 0\text{ mA}$)

●Block Diagrams / Standard Example Application Circuits

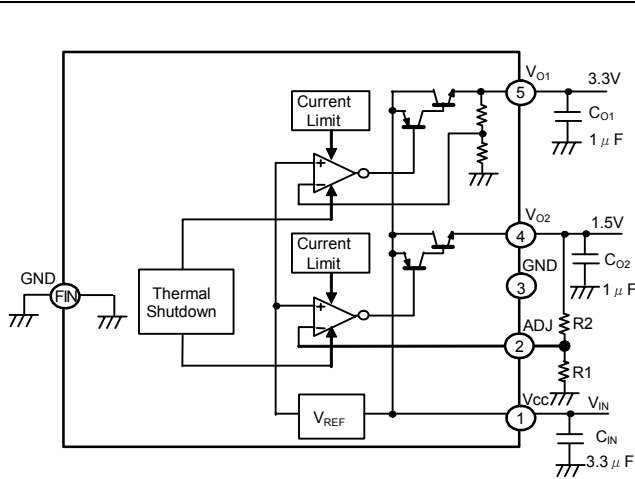

Fig.25 BA3259HFP Block Diagram

Pin No.	Pin name	Function
1	Vcc	Power supply pin
2	ADJ	Variable output voltage detection pin
3	GND	GND pin
4	Vo2	Variable output pin
5	Vo1	3.3 V output pin
FIN	GND	GND pin

PIN	External capacitor setting range
Vcc (1Pin)	Approximately 3.3 µF
Vo1 (5Pin)	1 µF to 1000 µF
Vo2 (4Pin)	1 µF to 1000 µF

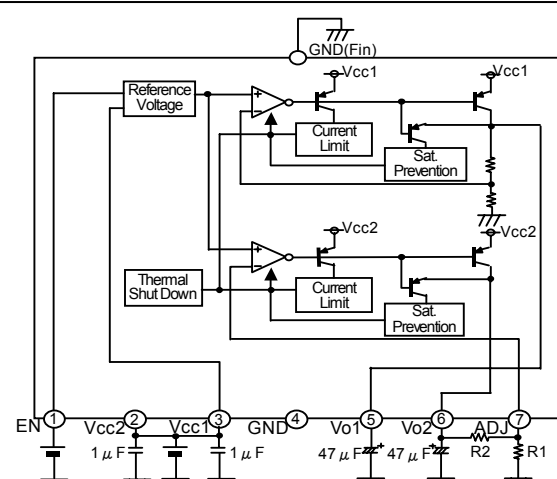
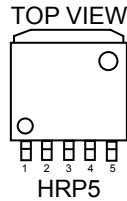
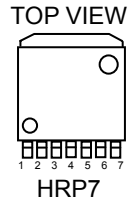

Fig.26 BA30E00WHFP Block Diagram

Pin No.	Pin name	Function
1	EN	Output on/off control pin: High active
2	Vcc2	Power supply pin 2
3	Vcc1	Power supply pin 1
4	GND	GND pin
5	Vo1	Power supply pin for 3.3 V output
6	Vo2	Variable output voltage detection pin (0.8 V to 3.3 V)
7	ADJ	Variable output voltage detection pin
FIN	GND	GND pin

PIN	External capacitor setting range
Vcc1 (3Pin)	Approximately 1 µF
Vcc2 (2Pin)	Approximately 1 µF
Vo1 (5Pin)	47 µF to 1000 µF
Vo2 (6Pin)	47 µF to 1000 µF



● Setting the Output Voltage Vo2

The following output voltage setting method applies to the variable output pin.

$$Vo2 = V_{ADJ} \times \left(1 + \frac{R2}{R1} \right) - R2 \times I_{ADJ}$$

V_{ADJ}: Output feedback reference voltage (0.8 V typ.)

I_{ADJ}: ADJ pin source current (0.05µA typ.: BA3259HFP)
(0.2µA typ.: BA30E00WHFP)

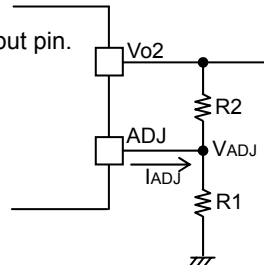

R1
BA3259HFP: 1 kΩ to 10 kΩ
BA30E00HFP: 1 kΩ to 5 kΩ
The above is recommended.

Note: Connect R1 and R2 to make output voltage settings as shown in Figs. 25 and 26. Keep in mind that the offset voltage caused by the current (I_{ADJ}) flowing out of the ADJ pin will become high if higher resistance is used.

●Function Explanation

1) Two-input power supply (BA30E00WHFP)

The input voltages (V_{cc1} and V_{cc2}) supply power to two outputs (Vo₁ and Vo₂, respectively). The power dissipation between the input and output pins can be suppressed for each output according to usage.

Efficiency comparison:

5V single input vs. 5V/3V two inputs

●Regulator with single input and two outputs

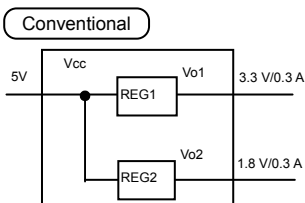

Power loss between input and output
(V_{cc} - Vo₁) × I_{o1} + (V_{cc} - Vo₂) × I_{o2}
= (5 - 3.3) × 0.3 + (5 - 1.8) × 0.3
= 0.51W + 0.96W
= 1.47W
→ Single 5V input results in decreased efficiency

●Regulator with two inputs and two outputs (Vo₂ = 1.8V, I_{o1} = I_{o2} = 0.3A)

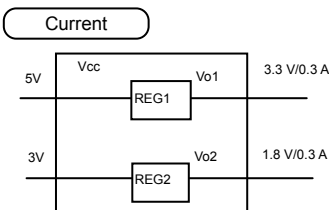

Power loss between input and output
(V_{cc1} - Vo₁) × I_{o1} + (V_{cc2} - Vo₂) × I_{o2}
= (5 - 3.3) × 0.3 + (5 - 1.8) × 0.3
= 0.51W + 0.36W
= 0.87W
Reduced power loss by 0.6W.
→ Additional 3V input improves efficiency

2) Standby function (BA30E00WHFP)

The standby function is operated through the EN pin. Output is turned on at 2.0 V or higher and turned off at 0.8 V or lower.

● Thermal Design

If the IC is used under the conditions of excess of the power dissipation, the chip temperature will rise, which will have an adverse effect on the electrical characteristics of the IC, such as a reduction in current capability. Furthermore, if the temperature exceeds T_{jmax} , element deterioration or damage may occur. Implement proper thermal designs to ensure that the power dissipation is within the permissible range in order to prevent instantaneous IC damage resulting from heat and maintain the reliability of the IC for long-term operation. Refer to the power derating characteristics curves in Fig. 27.

● Power Consumption P_c (W) Calculation Method:

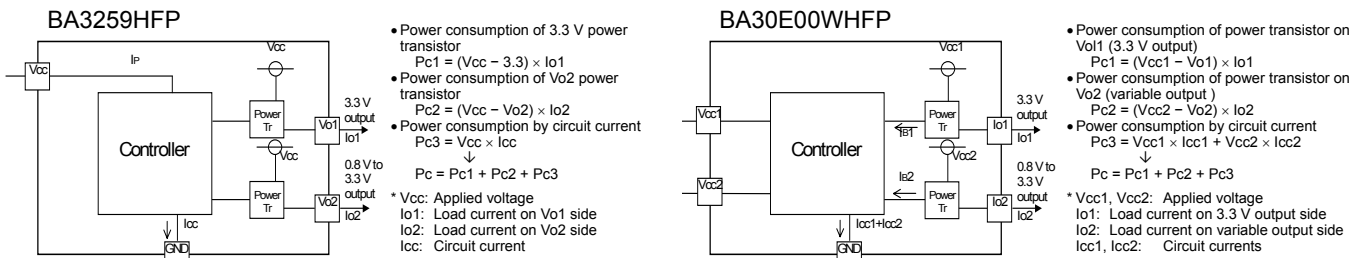

The I_{cc} (circuit current) varies with the load.

Refer to the above and implement proper thermal designs so that the IC will not be used under conditions of excess power dissipation P_d under all operating temperatures.

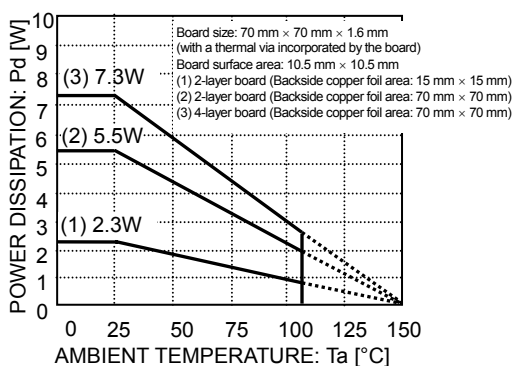

Fig. 27 Ambient Temperature vs. Power Dissipation

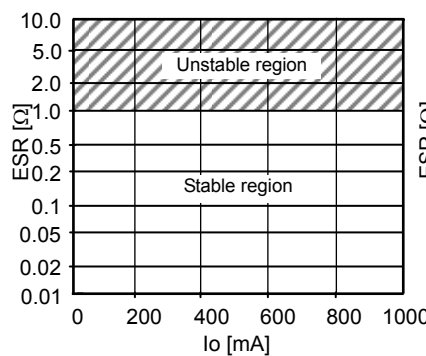

Fig.28 BA3259HFP ESR

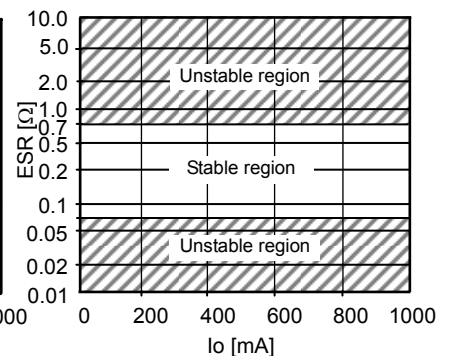
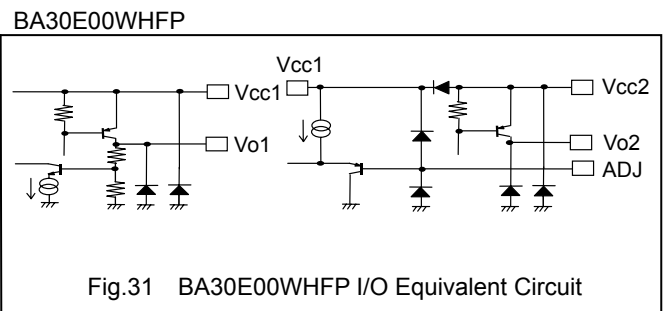
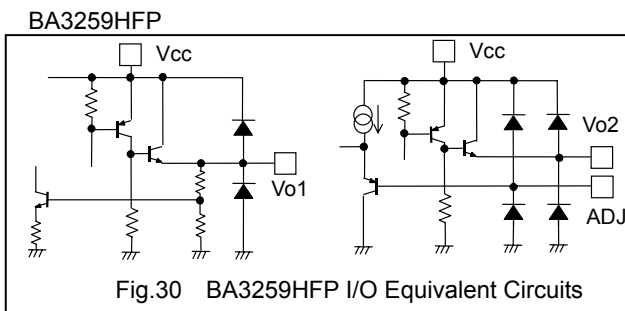

Fig.29 BA30E00WHFP ESR

● Input / Output Equivalent Circuits



● Explanation of external components

● BA3259HFP

1) Vcc (Pin 1)

It is recommended that a ceramic capacitor with a capacitance of approximately 3.3 μ F is placed between Vcc and GND at a position closest to the pins as possible.

2) Vo (Pins 4 and 5)

Insert a capacitor between Vo and GND in order to prevent output oscillation. The capacitor may oscillate if the capacitance changes as a result of temperature fluctuations. Therefore, it is recommended that a ceramic capacitor with a temperature coefficient of X5R or above and a maximum capacitance change (resulting from temperature fluctuations) of $\pm 10\%$ be used. The capacitance should be between 1 μ F and 1,000 μ F. (Refer to Fig. 28.)

● BA33E00HFP

1) Vcc1 (Pin 3) and Vcc2 (Pin 2)

Insert capacitors with a capacitance of 1 μ F between Vcc1 and GND and Vcc2 and GND. The capacitance value will vary depending on the application. Be sure to implement designs with sufficient margins.

2) Vo1 (Pin 5) and Vo2 (Pin 6)

Insert a capacitor between Vo and GND in order to prevent oscillation. The capacitance of the capacitor may greatly vary with temperature changes, making it impossible to completely prevent oscillation. Therefore, use a tantalum aluminum electrolytic capacitor with a low ESR (Equivalent Serial Resistance) that ensures good performance characteristics at low temperatures. The output oscillates if the ESR is too high or too low. Refer to the ESR characteristics in Fig. 29 and operate the IC within the stable operating region. If there is a sudden load change, use a capacitor with a higher capacitance. A capacitance between 47 μ F and 1,000 μ F is recommended.

● Operation Notes

1) Absolute maximum ratings

An excess in the absolute maximum ratings, such as supply voltage, temperature range of operating conditions, etc., can break down the devices, thus making impossible to identify breaking mode, such as a short circuit or an open circuit. If any over rated values will expect to exceed the absolute maximum ratings, consider adding circuit protection devices, such as fuses.

2) GND voltage

The potential of GND pin must be minimum potential in all operating conditions.

3) Thermal design

Use a thermal design that allows for a sufficient margin in light of the power dissipation (Pd) in actual operating conditions.

4) Inter-pin shorts and mounting errors

Use caution when positioning the IC for mounting on printed circuit boards. The IC may be damaged if there is any connection error or if pins are shorted together.

5) Actions in strong electromagnetic field

Use caution when using the IC in the presence of a strong electromagnetic field as doing so may cause the IC to malfunction.

6) Testing on application boards

When testing the IC on an application board, connecting a capacitor to a pin with low impedance subjects the IC to stress. Always discharge capacitors after each process or step. Always turn the IC's power supply off before connecting it to or removing it from a jig or fixture during the inspection process. Ground the IC during assembly steps as an antistatic measure. Use similar precaution when transporting or storing the IC.

7) Regarding input pin of the IC

This monolithic IC contains P+ isolation and P substrate layers between adjacent elements in order to keep them isolated. P-N junctions are formed at the intersection of these P layers with the N layers of other elements, creating a parasitic diode or transistor. For example, the relation between each potential is as follows:

When $GND > Pin A$ and $GND > Pin B$, the P-N junction operates as a parasitic diode.

When $GND > Pin B$, the P-N junction operates as a parasitic transistor.

Parasitic diodes can occur inevitable in the structure of the IC. The operation of parasitic diodes can result in mutual interference among circuits, operational faults, or physical damage. Accordingly, methods by which parasitic diodes operate, such as applying a voltage that is lower than the GND (P substrate) voltage to an input pin, should not be used.

8) Ground wiring patterns

When using both small signal and large current GND patterns, it is recommended to isolate the two ground patterns, placing a single ground point at the ground potential of application so that the pattern wiring resistance and voltage variations caused by large currents do not cause variations in the small signal ground voltage. Be careful not to change the GND wiring pattern of any external components, either.

9) Thermal Shutdown Circuit (TSD)

This IC incorporates a built-in thermal shutdown circuit for protection against thermal destruction. Should the junction temperature (Tj) reach the thermal shutdown ON temperature threshold, the TSD will be activated, turning off all output power elements. The circuit will automatically reset once the chip's temperature Tj drops below the threshold temperature. Operation of the thermal shutdown circuit presumes that the IC's absolute maximum ratings have been exceeded. Application designs should never make use of the thermal shutdown circuit.

10) Overcurrent protection circuit

An overcurrent protection circuit is incorporated in order to prevention destruction due to short-time overload currents. Continued use of the protection circuits should be avoided. Please note that current increases negatively impact the temperature.

11) Damage to the internal circuit or element may occur when the polarity of the Vcc pin is opposite to that of the other pins in applications. (I.e. Vcc is shorted with the GND pin while an external capacitor is charged.)

Use a maximum capacitance of 1000 mF for the output pins. Inserting a diode to prevent back-current flow in series with Vcc or bypass diodes between Vcc and each pin is recommended.

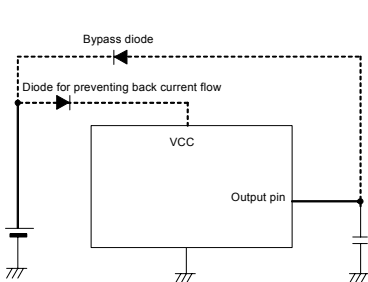

Fig. 32 Bypass diode

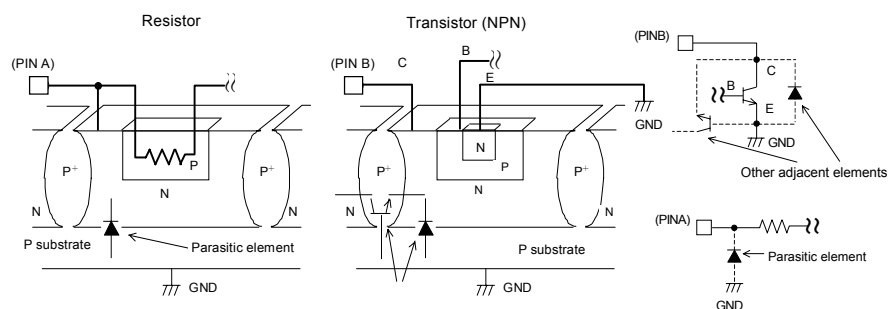

Fig. 33 Example of Simple Bipolar IC Architecture

Notes

- No technical content pages of this document may be reproduced in any form or transmitted by any means without prior permission of ROHM CO.,LTD.
- The contents described herein are subject to change without notice. The specifications for the product described in this document are for reference only. Upon actual use, therefore, please request that specifications to be separately delivered.
- Application circuit diagrams and circuit constants contained herein are shown as examples of standard use and operation. Please pay careful attention to the peripheral conditions when designing circuits and deciding upon circuit constants in the set.
- Any data, including, but not limited to application circuit diagrams information, described herein are intended only as illustrations of such devices and not as the specifications for such devices. ROHM CO.,LTD. disclaims any warranty that any use of such devices shall be free from infringement of any third party's intellectual property rights or other proprietary rights, and further, assumes no liability of whatsoever nature in the event of any such infringement, or arising from or connected with or related to the use of such devices.
- Upon the sale of any such devices, other than for buyer's right to use such devices itself, resell or otherwise dispose of the same, no express or implied right or license to practice or commercially exploit any intellectual property rights or other proprietary rights owned or controlled by
- ROHM CO., LTD. is granted to any such buyer.
- Products listed in this document are no antiradiation design.

The products listed in this document are designed to be used with ordinary electronic equipment or devices (such as audio visual equipment, office-automation equipment, communications devices, electrical appliances and electronic toys).

Should you intend to use these products with equipment or devices which require an extremely high level of reliability and the malfunction of which would directly endanger human life (such as medical instruments, transportation equipment, aerospace machinery, nuclear-reactor controllers, fuel controllers and other safety devices), please be sure to consult with our sales representative in advance.

It is our top priority to supply products with the utmost quality and reliability. However, there is always a chance of failure due to unexpected factors. Therefore, please take into account the derating characteristics and allow for sufficient safety features, such as extra margin, anti-flammability, and fail-safe measures when designing in order to prevent possible accidents that may result in bodily harm or fire caused by component failure. ROHM cannot be held responsible for any damages arising from the use of the products under conditions out of the range of the specifications or due to non-compliance with the NOTES specified in this catalog.

Thank you for your accessing to ROHM product informations.

More detail product informations and catalogs are available, please contact your nearest sales office.

ROHM Customer Support System

THE AMERICAS / EUROPE / ASIA / JAPAN

www.rohm.com

Contact us : webmaster@rohm.co.jp