

100-230VAC Input/24W Output

Isolated AC/DC Converter

BP5729

Absolute Maximum Ratings

Parameter	Symbol	Limits	Unit	Conditions
12-Pin input voltage	V _D	720	V	
12-Pin input current	I _D	1	Apk	
10-Pin input voltage	V _H	400	V	
7-Pin input voltage	V _{CC}	30	V	
6-Pin input voltage	V _{ZCD}	9.2	V	
6-Pin input current	I _{SOZCD}	-2.0	mA	
	I _{SZCD}	+3.0	mA	
1-Pin input current	I _{PC}	10	mA	
	P _O	24	W	DC248 to DC372V
Maximum power	P _O	12	W	DC120 to DC372V
Withstanding voltage	V _I	2.5	kV	1s (primary - secondary)
Allowable maximum surface temperature	T _{Cmax}	105	°C	Ambient temperature + The module self-heating ≤ T _{Cmax}
Operating temperature range	T _{opr}	-25 to +80	°C	
Storage temperature range	T _{stg}	-30 to +105	°C	

Electrical Characteristics

<In case of 12V output> (Unless otherwise noted, V_I=311V, rated load Ta=25°C)

Parameter	Symbol	Min.	Typ.	Max.	Unit	Conditions
Output voltage	V _O	11.4	12.0	12.6	V	I _O =2000mA
Output current	I _O	0	-	2000	mA	Refer to derating curve
Line regulation	V _r	-	13	200	mV	V _I =120 to 372V DC I _O =1000mA
Load regulation	V _l	-	20	200	mV	I _O =50 to 2000mA
Output ripple voltage	V _p	-	0.16	0.5	Vp-p	*
Power conversion efficiency	η	82	90	-	%	I _O =2000mA

* Pulse noise is not included.

Sample Application Circuit

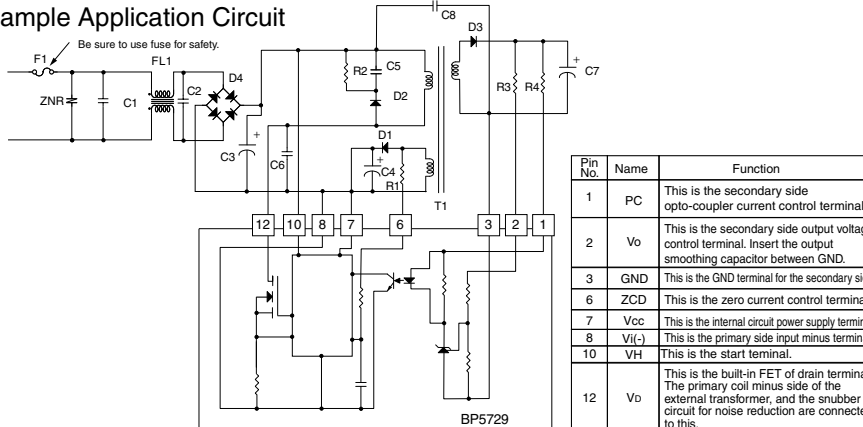

External Components Specifications

- C1,C2: Noise reduction capacitors
 - C3: Input smoothing capacitor
 - C4: V_{CC} smoothing capacitor
 - C5: Noise reduction capacitor
 - C6: Quasi-resonance capacitor
 - C7: Output smoothing capacitor
 - C8: Noise reduction capacitor
 - D1: Rectifier diode
 - D2: Rectifier diode
 - D3: Rectifier diode
 - D4: Diode bridge
 - R1: Resistor
 - R2: Resistor
 - R3: Output voltage setting resistor
 - R4: Resistor
 - T1: Switching transformer
 - F1: Fuse
 - FL1: AC line filter
 - ZNR: Varistor
- Limiting element voltage AC250V or higher, 0.1 to 0.22μF
 33μF / 450V General purpose type
 10μF / 50V Low impedance type
 2200pF / 630V
 Use if necessary
 1000μF / 35V x 2 Low impedance type
 Rated ripple current 4.5Arms or higher ESR 18mΩ or below
 2200pF / AC250V
 FRD 200V / 0.5A
 800V / 0.5A
 60V / 20A
 800V / 1A
 47kΩ ±1% 0.1W
 100kΩ ±5% 3W Limiting element voltage 300V or higher
 68kΩ ±1% 0.1W
 910Ω ±1% 0.1W
- Be sure to use this for safety
- A varistor is required to protect against lightning surges and static electricity.

Usage Precautions

- This product has built-in over current (reset type) and over voltage (latch type) protection functions to prevent destruction due to surges. Discontinue operation if protection circuits are continuously active.

Dimensions (Unit : mm)

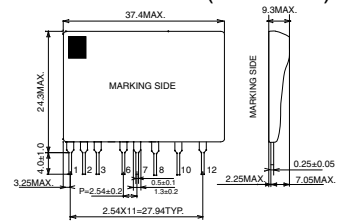

Derating Curve

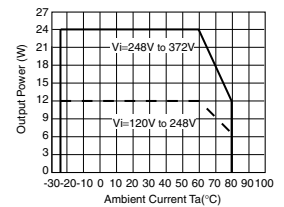

Switching Frequency

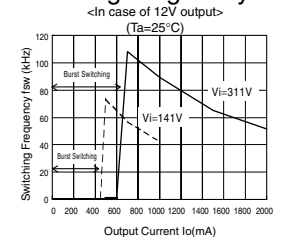

Conversion Efficiency

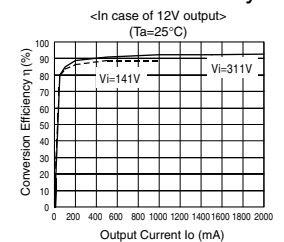

Load Regulation

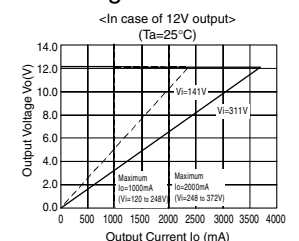

Surface Temperature Increase

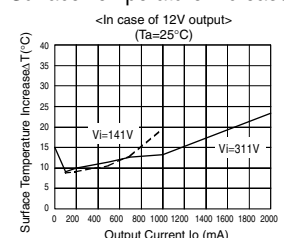

Power Module Usage Precautions

Safety Precautions

- 1) The products are designed and manufactured for use in ordinary electronic equipment (i.e. AV/OA/telecommunication/amusement equipment, home appliances). Please consult with the Company's (ROHM) sales staff if intended for use in devices requiring high reliability (e.g. medical/transport/aircraft/spacecraft equipment, nuclear power/fuel controllers, automotive/safety devices) and whose malfunction may result in injury or death. In this case, failsafe measures must be taken, including the following:
 - [a] Installation of protection circuits in order to improve system safety
 - [b] Incorporation of redundant circuits in the case of single-circuit failure
- 2) The products are designed for use under normal conditions. Application in special environments can cause a deterioration in product performance. Therefore, verification and confirmation of product performance, prior to use, is recommended. The following environments are considered to be 'special':
 - [a] Outdoors, exposed to direct sunlight or dust
 - [b] In contact with liquids, such as water, oils, chemicals, or organic solvents
 - [c] In areas where exposure to the sea air or corrosive gases (i.e. Cl₂, H₂S, NH₃, SO₂, NO₂) can occur
 - [d] In places where the products may be in contact with static electricity or electromagnetic waves
 - [e] In proximity to heat-producing items, plastic cords, or flammable materials
 - [f] In contact with sealing or coating products, such as resin
 - [g] In contact with unclean solder or exposed to water or water-soluble cleaning agents used after soldering
 - [h] In areas where dew condensation occurs
- 3) The products are not designed to be radiation resistant
- 4) The Company is not responsible for any problems resulting from use of the products under conditions not recommended herein.
- 5) The Company should be notified of any product safety issues. Moreover, product safety issues should be periodically monitored by the customer.

Application Notes

- 1) A sufficient margin must be allowed if changes are made to the peripheral circuit due to variations in the inherent tolerances of the external components as well as transient and static characteristics. In addition, please be aware that the Company has not conducted investigations on whether or not particular changes in the example application circuits would result in patent infringement.
- 2) The application examples, their constants, and other types of information contained herein are applicable only when the products are used in accordance with standard methods. Therefore, if mass production is intended, sufficient consideration to external conditions must be made.

Notes Regarding Industrial Property

- 1) The specifications included herein contain information related to the Company's industrial property. Their use other than pertaining to the relevant products is forbidden. Duplication and/or disclosure to a third party without express written permission is strictly prohibited.
- 2) Product information and data, including application examples, contained in the specifications are for reference purposes only; the Company does not guarantee the industrial/intellectual property rights or any other rights of a third party. Accordingly, the Company shall not bear responsibility for:
 - [a] Infringement of the intellectual property rights of a third party
 - [b] Problems arising from the use of the products listed herein
- 3) The Company prohibits the purchaser from exercising or using the intellectual/industrial property rights or any rights belonging to or are controlled by the Company, other than the right to use, sell, or dispose of the products.

Power Module Usage Precautions

Safety Precautions

- 1) The products are designed and manufactured for use in ordinary electronic equipment (i.e. AV/OA/telecommunication/amusement equipment, home appliances). Please consult with the Company's (ROHM) sales staff if intended for use in devices requiring high reliability (e.g. medical/transport/aircraft/spacecraft equipment, nuclear power/fuel controllers, automotive/safety devices) and whose malfunction may result in injury or death. In this case, failsafe measures must be taken, including the following:
 - [a] Installation of protection circuits in order to improve system safety
 - [b] Incorporation of redundant circuits in the case of single-circuit failure
- 2) The products are designed for use under normal conditions. Application in special environments can cause a deterioration in product performance. Therefore, verification and confirmation of product performance, prior to use, is recommended. The following environments are considered to be 'special':
 - [a] Outdoors, exposed to direct sunlight or dust
 - [b] In contact with liquids, such as water, oils, chemicals, or organic solvents
 - [c] In areas where exposure to the sea air or corrosive gases (i.e. Cl₂, H₂S, NH₃, SO₂, NO₂) can occur
 - [d] In places where the products may be in contact with static electricity or electromagnetic waves
 - [e] In proximity to heat-producing items, plastic cords, or flammable materials
 - [f] In contact with sealing or coating products, such as resin
 - [g] In contact with unclean solder or exposed to water or water-soluble cleaning agents used after soldering
 - [h] In areas where dew condensation occurs
- 3) The products are not designed to be radiation resistant
- 4) The Company is not responsible for any problems resulting from use of the products under conditions not recommended herein.
- 5) The Company should be notified of any product safety issues. Moreover, product safety issues should be periodically monitored by the customer.

Application Notes

- 1) A sufficient margin must be allowed if changes are made to the peripheral circuit due to variations in the inherent tolerances of the external components as well as transient and static characteristics. In addition, please be aware that the Company has not conducted investigations on whether or not particular changes in the example application circuits would result in patent infringement.
- 2) The application examples, their constants, and other types of information contained herein are applicable only when the products are used in accordance with standard methods. Therefore, if mass production is intended, sufficient consideration to external conditions must be made.

Notes Regarding Industrial Property

- 1) The specifications included herein contain information related to the Company's industrial property. Their use other than pertaining to the relevant products is forbidden. Duplication and/or disclosure to a third party without express written permission is strictly prohibited.
- 2) Product information and data, including application examples, contained in the specifications are for reference purposes only; the Company does not guarantee the industrial/intellectual property rights or any other rights of a third party. Accordingly, the Company shall not bear responsibility for:
 - [a] Infringement of the intellectual property rights of a third party
 - [b] Problems arising from the use of the products listed herein
- 3) The Company prohibits the purchaser from exercising or using the intellectual/industrial property rights or any rights belonging to or are controlled by the Company, other than the right to use, sell, or dispose of the products.

Notes

No copying or reproduction of this document, in part or in whole, is permitted without the consent of ROHM Co.,Ltd.

The content specified herein is subject to change for improvement without notice.

The content specified herein is for the purpose of introducing ROHM's products (hereinafter "Products"). If you wish to use any such Product, please be sure to refer to the specifications, which can be obtained from ROHM upon request.

Examples of application circuits, circuit constants and any other information contained herein illustrate the standard usage and operations of the Products. The peripheral conditions must be taken into account when designing circuits for mass production.

Great care was taken in ensuring the accuracy of the information specified in this document. However, should you incur any damage arising from any inaccuracy or misprint of such information, ROHM shall bear no responsibility for such damage.

The technical information specified herein is intended only to show the typical functions of and examples of application circuits for the Products. ROHM does not grant you, explicitly or implicitly, any license to use or exercise intellectual property or other rights held by ROHM and other parties. ROHM shall bear no responsibility whatsoever for any dispute arising from the use of such technical information.

The Products specified in this document are intended to be used with general-use electronic equipment or devices (such as audio visual equipment, office-automation equipment, communication devices, electronic appliances and amusement devices).

The Products specified in this document are not designed to be radiation tolerant.

While ROHM always makes efforts to enhance the quality and reliability of its Products, a Product may fail or malfunction for a variety of reasons.

Please be sure to implement in your equipment using the Products safety measures to guard against the possibility of physical injury, fire or any other damage caused in the event of the failure of any Product, such as derating, redundancy, fire control and fail-safe designs. ROHM shall bear no responsibility whatsoever for your use of any Product outside of the prescribed scope or not in accordance with the instruction manual.

The Products are not designed or manufactured to be used with any equipment, device or system which requires an extremely high level of reliability the failure or malfunction of which may result in a direct threat to human life or create a risk of human injury (such as a medical instrument, transportation equipment, aerospace machinery, nuclear-reactor controller, fuel-controller or other safety device). ROHM shall bear no responsibility in any way for use of any of the Products for the above special purposes. If a Product is intended to be used for any such special purpose, please contact a ROHM sales representative before purchasing.

If you intend to export or ship overseas any Product or technology specified herein that may be controlled under the Foreign Exchange and the Foreign Trade Law, you will be required to obtain a license or permit under the Law.



Thank you for your accessing to ROHM product informations.
More detail product informations and catalogs are available, please contact us.

ROHM Customer Support System

<http://www.rohm.com/contact/>