

System Motor Driver Series for CD/DVD Drive & Recorder

System Motor Driver IC for Slim Drive (3 sensors) BH5510KVT



● Description

BH5510KVT is an energy-saving, low noise PWM 6ch IC developed for the spindle motor, the actuator coil, and the stepping motor drive of notebook PCs and DVD camcorders. Power MOSFET is used for the output steps, and the energy-saving of the set is possible. SIPWM^{X2} is adopted for the spindle motor driver and is ideal for decreasing noise of the set.

● Features

- 1) The spindle motor driver achieves a low noise by SIPWM^{X2} super low noise drive method of an original ROHM.
- 2) The spindle motor driver built the gain switch function in, and it enabled the low-speed stability rotation.
- 3) Actuator coil driver (CH1-CH2) does not have a very small dead zone with good linearity.
- 4) Actuator coil driver (CH1-CH2) can be optimized by matching the frequency characteristic to the load characteristic with the external R.C. network
- 5) An eject function can be used when the tilt coil load is not used by the set.
- 6) STBY input (pin4) is three state input, and controls the spindle motor driver only.

● Applications

Portable optical disk equipment, such as notebook PC and DVD camcorders

● Absolute maximum ratings Ta=25°C

Parameter	Symbol	Limits	Unit
Power MOS circuit power supply voltage	Vcc	6	V
Control circuit power supply voltage	PVcc	6	V
Maximum driver output current	IoMAX	3 *1	A
Power dissipation	Pd	1.37 *2	W
Operating temperature range	Topr	-40 to 85	°C
Storage temperature range	Tstg	-55 to 150	°C

*1 The current is guaranteed 3.0A in case of the short-circuit braking mode and the current which is turned on/off in a duty-ratio of less than 1/10 with a maximum on-time of 5msec.

*2 PCB (70mm×70mm×1.6mm, occupied copper foil is less than 3%, glass epoxy) mounting.
Reduce by 11.0mW/°C over 25°C.

● Recommended operating conditions Ta=25°C

Parameter	Symbol	MIN.	TYP.	MAX.	Unit
Power MOS circuit power supply voltage	PVcc	3.0	5.0	5.5	V
Control circuit power supply voltage	Vcc	4.0	5.0	5.5	V
Atmosphere	Ta	-10	25	70	°C

● Block diagram

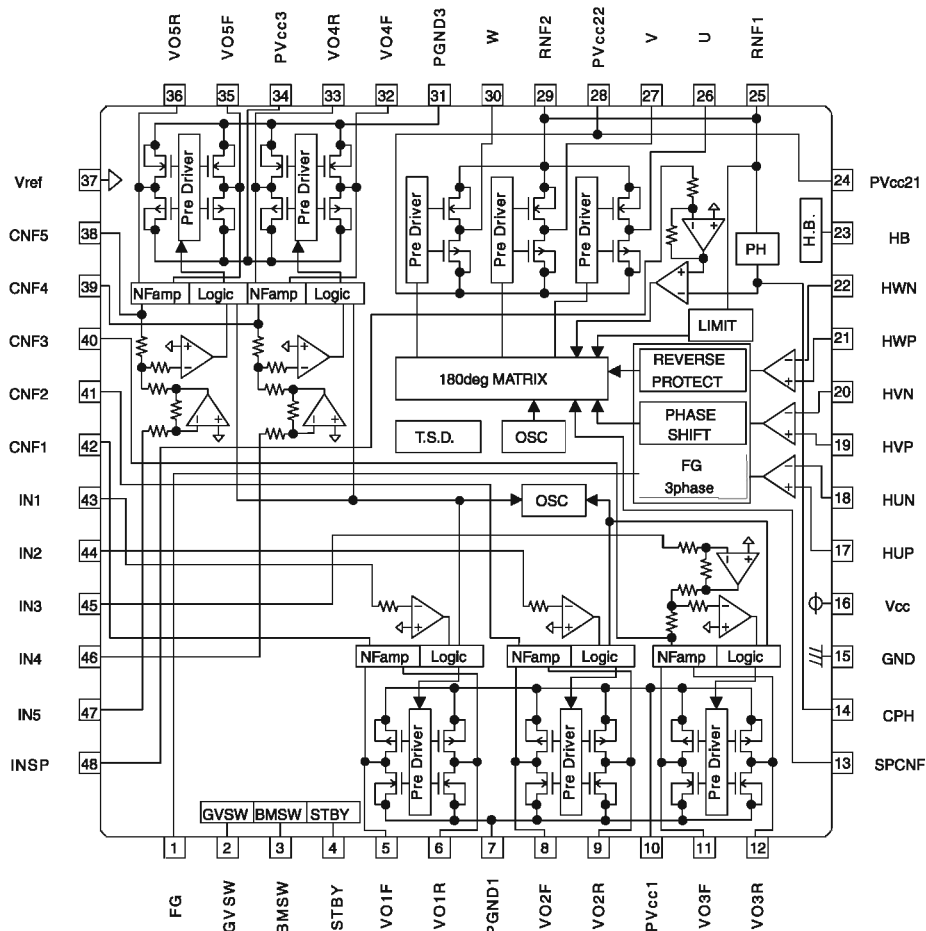

● Pin description

Pin No	Symbol	Description	Pin No	Symbol	Description
1	FG	Frequency generator output	25	RNF1	Spindle driver current sense output1
2	GVSW	Control for gain of spindle	26	U	Spindle driver output U
3	BMSW	Control for brake mode	27	V	Spindle driver output V
4	STBY	Control for standby	28	PVcc22	Spindle driver power supply22
5	VO1F	PWM Driver (CH1) positive output	29	RNF2	Spindle driver current sense output2
6	VO1R	PWM Driver (CH1) negative output	30	W	Spindle driver output W
7	PGND1	PWM driver power ground1	31	PGND3	PAM driver power ground3
8	VO2F	PWM Driver (CH2) positive output	32	VO4F	PWM driver (CH4) positive output
9	VO2R	PWM Driver (CH2) negative output	33	VO4R	PWM driver (CH4) negative output
10	PVcc1	PWM driver power supply1	34	PVcc3	PWM driver power supply3
11	VO3F	PWM Driver (CH3) positive output	35	VO5F	PWM driver (CH5) positive output
12	VO3R	PWM Driver (CH3) negative output	36	VO5R	PWM driver (CH5) negative output
13	SPCNF	Spindle driver feedback filter	37	Vref	Reference voltage input
14	CPH	P/H time constant setting	38	CNF5	PWM driver (CH5) feedback filter
15	GND	Pre unit ground	39	CNF4	PWM driver (CH4) feedback filter
16	Vcc	Pre unit power supply	40	CNF3	PWM driver (CH3) feedback filter
17	HUP	Hall amp. U positive input	41	CNF2	PWM driver (CH2) feedback filter
18	HUN	Hall amp. U negative input	42	CNF1	PWM driver (CH1) feedback filter
19	HVP	Hall amp. V positive input	43	IN1	PWM driver (CH1) input
20	HVN	Hall amp. V negative input	44	IN2	PWM driver (CH2) input
21	HWP	Hall amp. W positive input	45	IN3	PWM driver (CH3) input
22	HWN	Hall amp. W negative input	46	IN4	PWM driver (CH4) input
23	HB	Hall bias	47	IN5	PWM driver (CH5) input
24	PVcc21	Spindle driver power supply21	48	INSP	Spindle driver input

Positive/negative of the output terminals are determined in reference to those of the input terminals.

● Equivalent-circuit diagram of the terminals

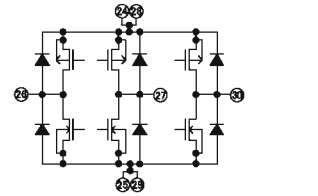
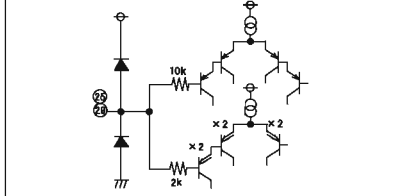
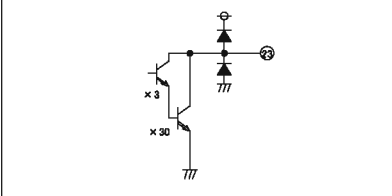
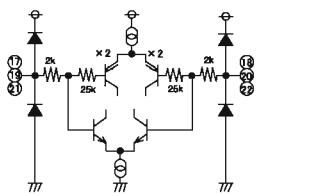
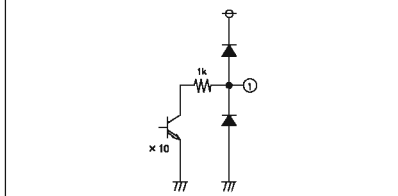
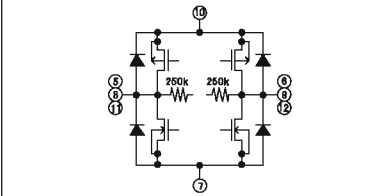
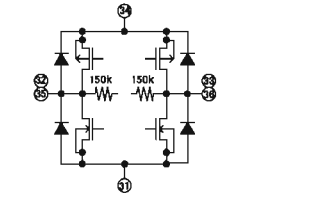
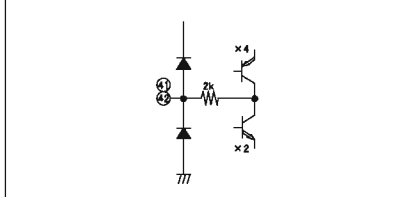
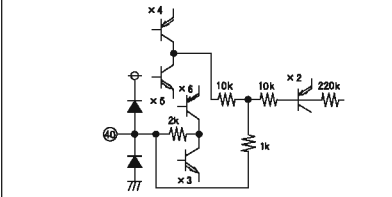
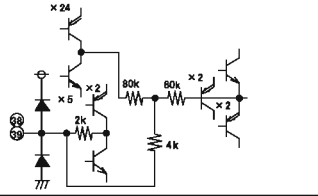
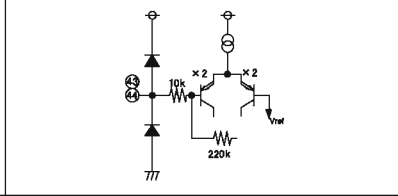
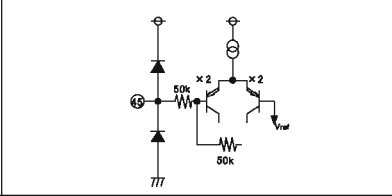
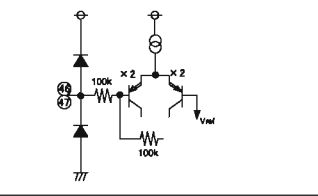
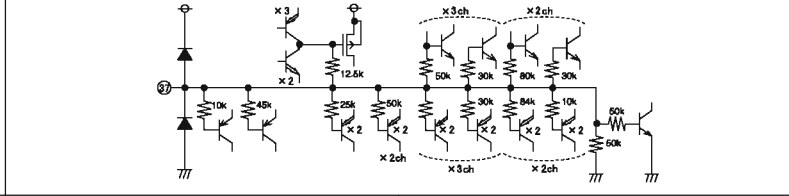
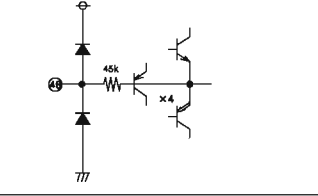
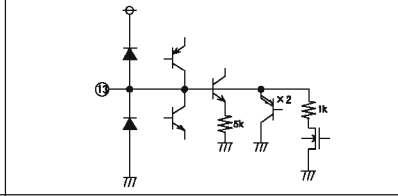
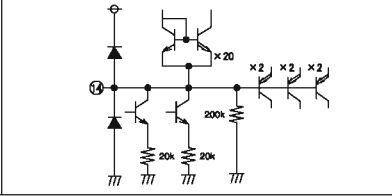
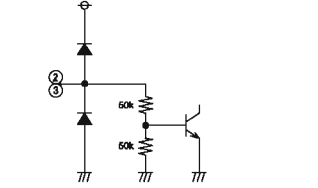
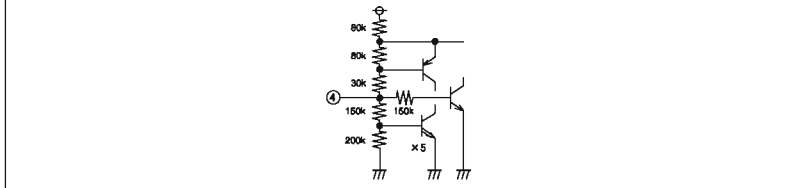
<p>Spindle driver output</p> 	<p>Spindle driver current detection</p> 	<p>Hall bias</p> 
<p>Hall signal input</p> 	<p>FG signal output</p> 	<p>PWM driver output (CH1,2,3)</p> 
<p>PWM driver output (CH4,5)</p> 	<p>PWM driver feedback filter (CH1,2)</p> 	<p>PWM driver feedback filter (CH3)</p> 
<p>PWM driver feedback filter (CH4,5)</p> 	<p>input (CH1,2)</p> 	<p>input (CH3)</p> 
<p>input (CH4,5)</p> 	<p>Reference voltage input</p> 	
<p>Spindle driver input</p> 	<p>Spindle driver feedback filter</p> 	<p>P/H output</p> 
<p>Control for GVSW, BMSW</p> 	<p>Control for standby</p> 	

● Electrical characteristics

(Unless otherwise noted Ta=25°C, Vcc=PVcc=5V, Vref=1.25V, RL(act)=8Ω+47uH, RL(SP)=2Ω+47uH, SPRNF=0.2Ω)

Parameter	Symbol	MIN	TYP	MAX	Unit	Condition
Current in standby mode	IST	—	—	0.1	mA	VST=1.0V
Quiescent current	Icc	—	10.5	20	mA	VST=2.6V
ACT PWM Driver (CH1,2,3) (R1=10kΩ, R2=150Ω)						
Input dead zone (one side)	VDZACT1,2,3	—	—	3	mV	Value of design guarantee
Output offset voltage	VOO1,2,3	-50	—	50	mV	
Voltage gain	GVC1,2,3	12.0	14.0	16.0	dB	
Gain error by polarity	ΔGVC1,2,3	-2	0	2	dB	
PWM frequency	f1,2,3,CH	240	300	360	kHz	
Output ON resistance	RON1,2,3	—	1.3	2.0	Ω	I _o =500mA
STP PWM Driver (CH4,5)						
Input dead zone(one side)	VDZSTP4,5	10	30	50	mV	
Output offset voltage	VOO4,5	-50	—	50	mV	
Voltage gain	GVC4,5	12.0	14.0	16.0	dB	
Gain error by polarity	ΔGVC4,5	-2	0	2	dB	
PWM frequency	f4,5CH	240	300	360	kHz	
Output ON resistance	RON4,5	—	1.5	2.3	Ω	I _o =500mA
3-phase PWM Driver						
Hall bias/Hall amp						
Hall bias output voltage	VHB	0.8	1.0	1.2	V	IHB=10mA
Input bias current	IHIB	-2	0	2	μA	
Hall input level (one side)	VHI	30	—	—	mVpp	
Common mode input range	VHICM	1	—	3.8	V	
Torque control/FG						
Input dead zone of gm1 (one side)	VDZSP 1	2	50	100	mV	gm1 (GVSW=Low)
Input dead zone of gm2 (one side)	VDZSP 2	10	210	460	mV	gm2 (GVSW=Hi)
Input-output gain 1	gm 1	0.8	1.0	1.2	A/V	Effective current(GVSW=Low) SPRNF=0.2Ω
Input-output gain 2	gm 2	0.16	0.2	0.24	A/V	Effective current(GVSW=Hi) SPRNF=0.2Ω
PWM frequency	fSP	60	80	100	kHz	
Output ON resistance	RONSP(U,V,W)	—	0.6	1.2	Ω	I _o =500mA
Output limit voltage	VLIMSP	0.16	0.20	0.24	V	1A Limit when SPRNF=0.2Ω
FG High-level output voltage	VFGH	4.7	4.9	—	V	Pull-up resistor is 100KΩ
FG Low-level output voltage	VFGL	—	0.1	0.3	V	Pull-up resistor is 100KΩ
GVSW ON level voltage range	VGON	2.0	—	—	V	gm 2
GVSW OFF level voltage range	VGOFF	—	—	0.5	V	gm 1
BMSW SB voltage range	VBMS	2.0	—	—	V	Short brake
BMSW REV voltage range	VBMR	—	—	0.5	V	Reverse brake
Others						
Vref drop mute ON threshold voltage	VMVref	—	0.7	1.0	V	
Vcc drop mute ON threshold voltage	VMVcc	3.2	3.6	4.0	V	
Standby High-level voltage range	VSTH	2.6	—	3.3	V	
Standby Hi-Z level voltage range	VSTHZ	1.6	—	2.0	V	OPEN(Hi-Z) is also available.
Standby Low-level voltage range	VSTL	0	—	1.0	V	

*This IC is not designed to be radiation-resistant.

● Test circuit

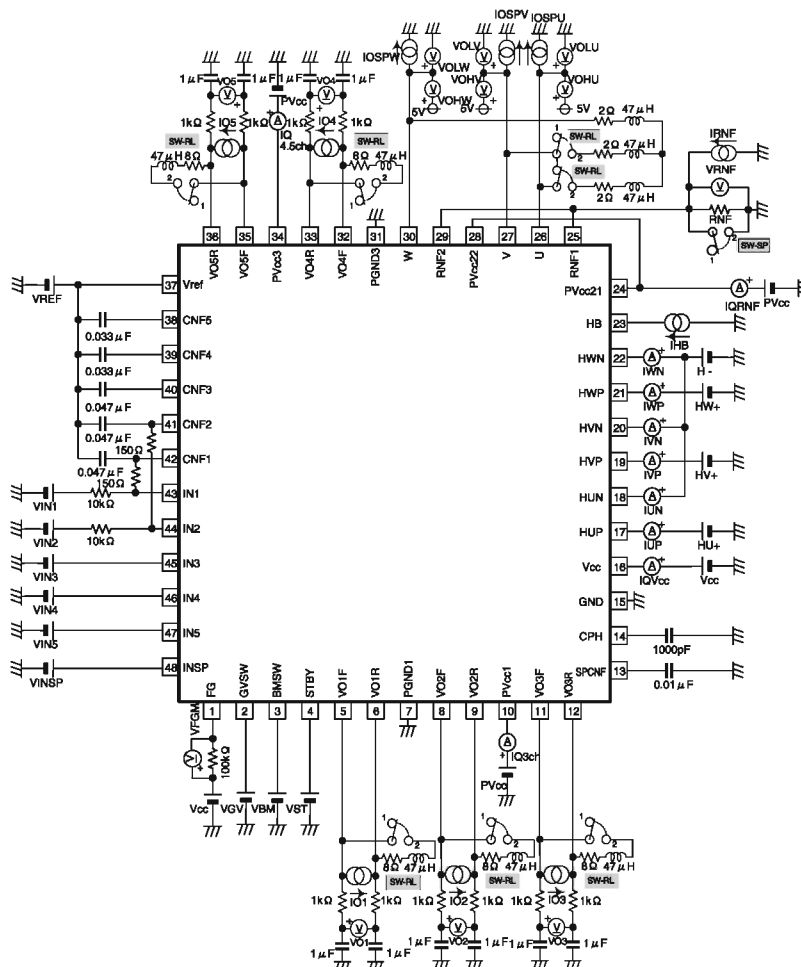

● Functional description

1) Torque command (pin48), CPH (14pin)

The relation between the torque command input signal and the input signal to CPH terminal is expressed in the figure below.

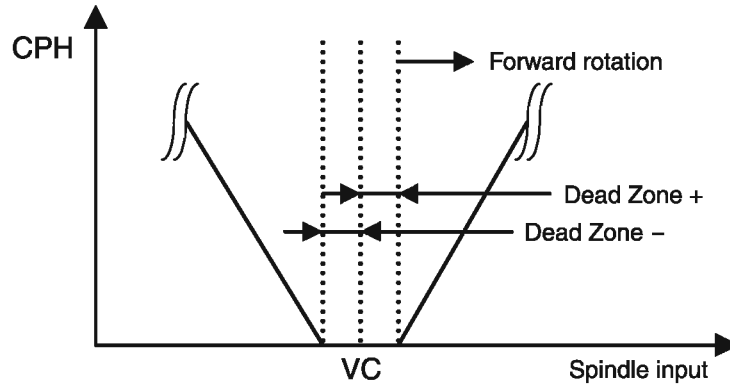

The input-output transfer gain from the spindle input terminal to CPH terminal (PWM-output peak-current), gm_1 , depends on the resistance of RNF-output-current detection resistor.

$$gm_1 = 1 / (5 \cdot RNF) \quad (A / V)$$

The input-output transfer gain, gm_2 , depends on the resistance of RNF-output-current detection resistor.

$$gm_2 = 1 / (25 \cdot RNF) \quad (A / V)$$

The output-limit current $ILIM$ is

$$ILIM = VLIMSP / RNF \quad (A)$$

2) Hall input (pin17 to pin22) and Hall bias (pin23)

Either series or parallel connection of the Hall elements can be used. Set the input voltage to the Hall elements to 1.0V to 3.8V and larger than 30m Vp-p.

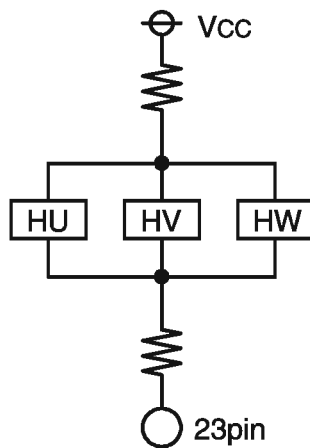

Parallel connection

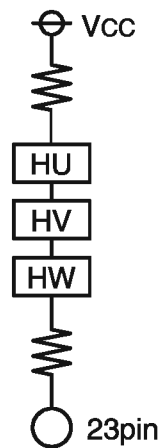

Series connection

3) Input/output timing chart

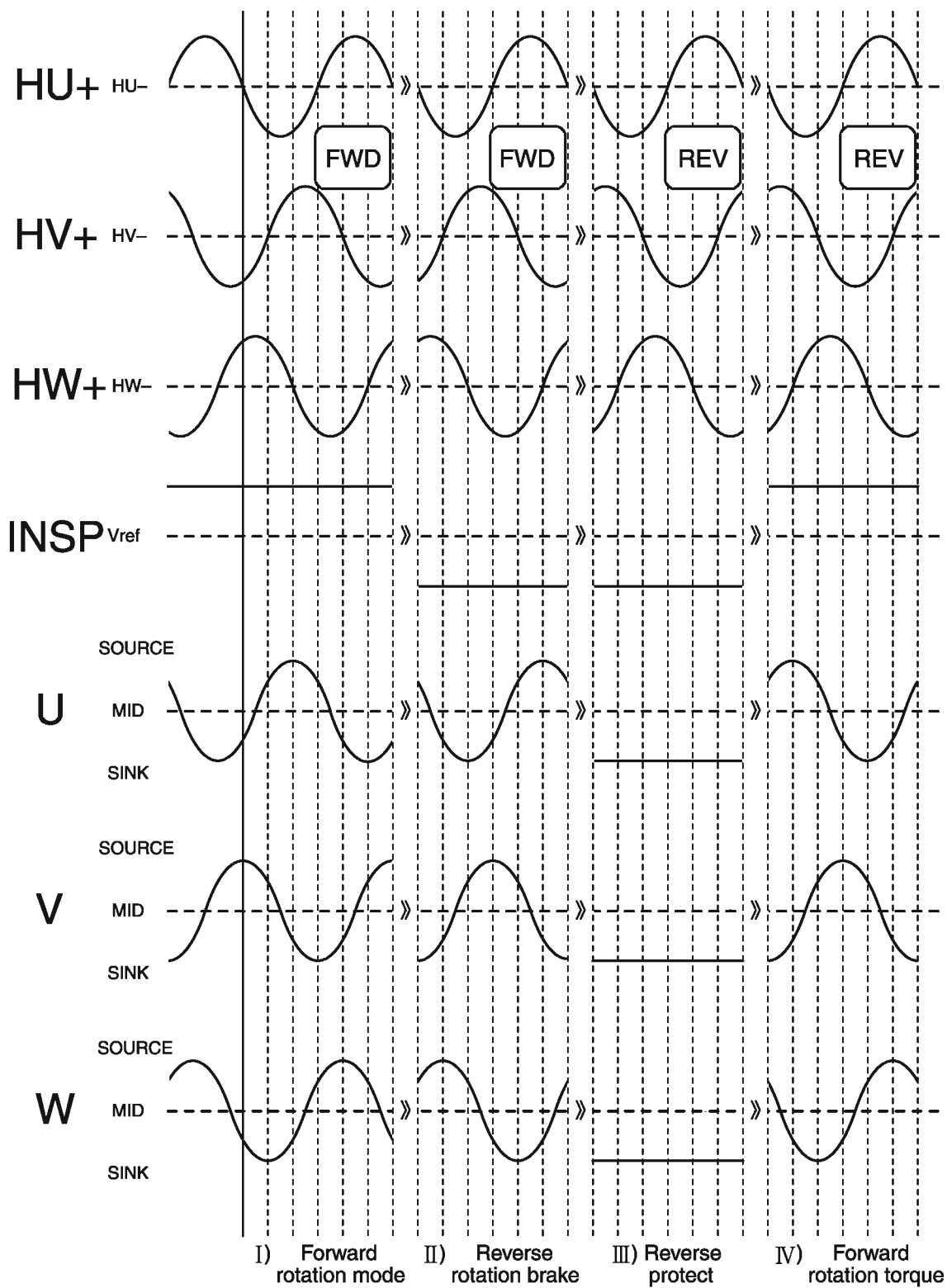

4) Standby control terminal (4pin)

STBY terminal - 3STATE matrix

	Voltage at STBY terminal	CH1 ~ 5	SPINDLE
LOW	0V ~ 1.0V	MUTE	MUTE
HIZ	1.6V ~ 2.0V	MUTE	ACTIVE
HI	2.6V ~ 3.3V	ACTIVE	ACTIVE

5) Muting

a) Vref-drop muting

When the voltage at Vref terminal (pin37) drops to lower than 0.7V (Typ.), the outputs of all the channels are brought to open state. Set the Vref terminal voltage to larger than 1.0V.

b) Vcc-drop muting

When the voltage at Vcc terminal (pin16) drops to lower than 3.6V (Typ.), the outputs of all the channels are brought to open state. The hysteresis voltage width is 140mV(Typ.).

6) Thermal-shutdown

A thermal-shutdown circuit (over-temperature protection circuit) is built in to prevent the IC from thermal breakdown.

Use the IC under the allowable loss (1.37W), the junction temperature rises, and the thermal-shutdown circuit works at the junction temperature of 175°C(Typ.) (the outputs of all the channels are brought to open status). When the junction temperature drops to 150°C(Typ.), the IC start operating again.

● External parts description

1) Filtering capacitor

It is recommended to connect SPCNF=0.01μF/CNF1 to 3=0.047μF/CNF4.5=0.033μF filtering capacitor to SPCNF and CNF terminals. This capacitor filters PWM output carrier frequency. Dispersion of the cut off frequency due to circuit board wiring layout is taken into consideration. If it is difficult to filter at the recommended value due to circuit board wiring layout, the capacity can be increased. In this case, note that the output transmission delay time may be longer.

2) P/H time constant capacitor

It is recommended to connect 1000pF P/H time constant capacitor to CPH terminal. It is the one to hold a steep peak current, and if it is far somewhat arranged from IC, the effect of holding decreases by the wiring impedance and the noise, etc. Please examine the capacitor between CPH and GND to arrange it near IC. Please set the P/H time constant with 1000pF or more and with 1/10 or less of SPCNF filtering capacitor to stabilize the rotation speed.

3) Bypass capacitor

Connect a bypass capacitor (0.1μF) across the supply voltage lines close to the IC pins.

● Cautions in using the IC

1) Absolute maximum ratings

This IC might be destroyed when the absolute maximum ratings, such as impressed voltages (Vcc, VM) or the operating temperature range (Topr), is exceeded, and whether the destruction is short circuit mode or open circuit mode cannot be specified. Please take into consideration the physical countermeasures for safety, such as fusing, if a particular mode that exceeds the absolute maximum rating is assumed.

2) Reverse polarity connection

Connecting the power line to the IC in reverse polarity (from that recommended) will damage the part. Please utilize the direction protection device as a diode in the supply line.

3) Power supply line

Due to switching and EMI noise generated by magnetic components (inductors and motors), using electrolytic and ceramic suppress filter capacitors (0.1μF) close to the IC power input terminals (Vcc and GND) is recommended. Please note: the electrolytic capacitor value decreases at lower temperatures.

4) GND line

The ground line is where the lowest potential and transient voltages are connected to the IC.

5) Thermal design

Do not exceed the power dissipation (Pd) of the package specification rating under actual operation, and please design enough temperature margins.

6) Short circuit mode between terminals and wrong mounting

Do not mount the IC in the wrong direction and be careful about the reverse-connection of the power connector. Moreover, this IC might be destroyed when the dust short the terminals between them or GND.

7) Radiation

Strong electromagnetic radiation can cause operation failures.

8) ASO(Area of Safety Operation)

When using the IC, set the output transistor so that it does not exceed absolute maximum ratings or ASO.

9) TSD(Thermal Shut-Down)

The TSD is activated when the junction temperature(T_J)reaches175°C(with +/-25°C hysteresis), and the output terminal is switched to Hi-z. The TSD circuit designed to shut the IC off to prevent runaway thermal operation. It is not designed to protect or guarantee its operation. Do not continue to use the IC after operating this circuit.

10) Capacitor between output and GND

If a large capacitance value is connected between the output and ground pins, and if the VCC falls to 0 V or becomes shorted with the ground pin, the current stored in the capacitor may flow to the output pin. This can cause damage to the IC. Set capacitors connected between the output and ground pins to values that fall within the recommended range.

11) Inspection by the set circuit board

When testing the IC on an application board, connecting a capacitor to a pin with low impedance subjects the IC to stress. Always discharge capacitors after each process or step. Always turn the IC's power supply off before connecting it to, or removing it from a jig or fixture, during the inspection process. Ground the IC during assembly steps as an antistatic measure. Use similar precaution when transporting and storing the IC.

12) Noise due to reverse polarity voltage

This monolithic IC contains P+ isolation and P substrate layers between adjacent elements to keep them isolated. PñN junctions are formed at the intersection of these P layers with the N layers of other elements, creating a parasitic diode or transistor. For example, the relation between each potential is as follows:

When GND > Pin A and GND > Pin B, the P-N junction operates as a parasitic diode.

When Pin B > GND > Pin A, the PñN junction operates as a parasitic transistor.

Parasitic diodes can occur inevitably in the structure of the IC. The operation of parasitic diodes can result in mutual interference among circuits, operational faults, or physical damage. Accordingly, methods by which parasitic diodes operate, such as applying a voltage that is lower than the GND (P substrate) voltage to an input pin, should not be used.

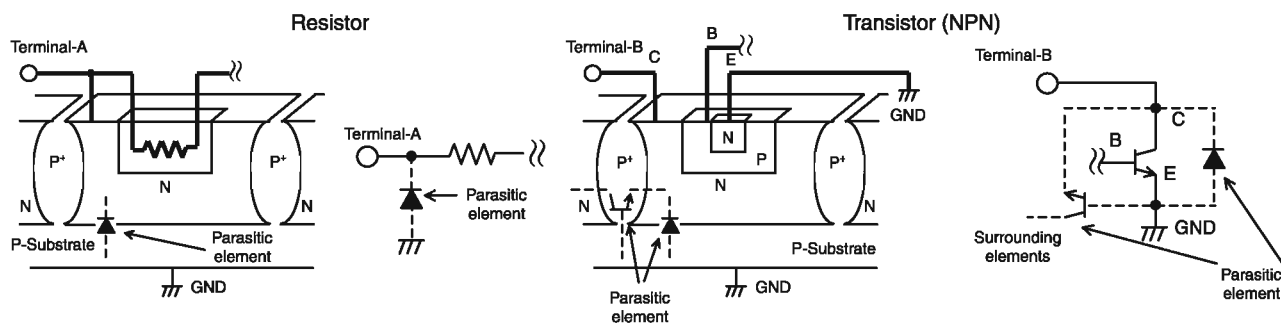

Simplified structure of IC

13) Ground wiring pattern

The power supply and ground lines must be as short and thick as possible to reduce line impedance. Fluctuating voltage on the power ground line may damage the device.

14) Application circuit

It is one sample that explains standard operation and usage of this IC about the described example of the application circuit and information on the constant etc. Therefore, please be sure to consult with our sales representative in advance before mass production design, when a circuit different from application circuit is composed of external.

Application circuit ①

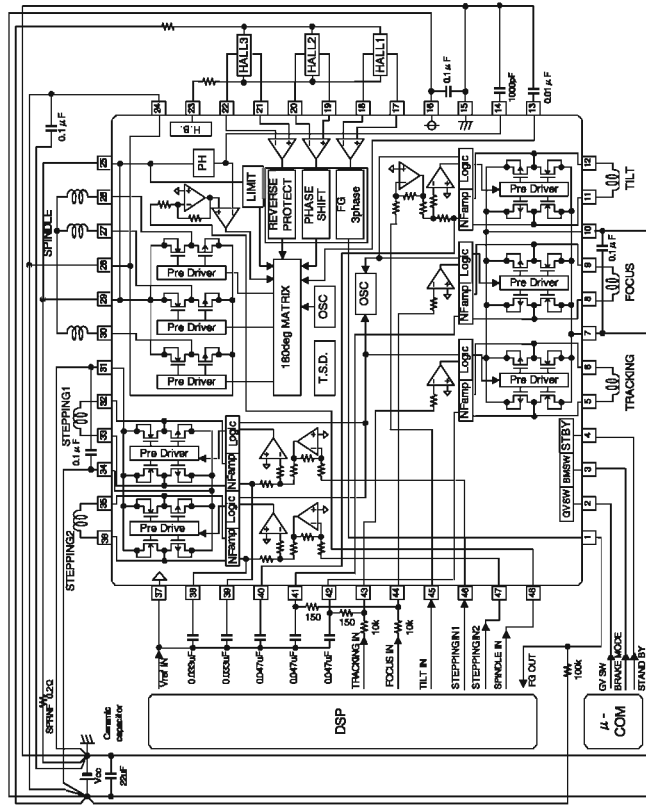

Application circuit ②

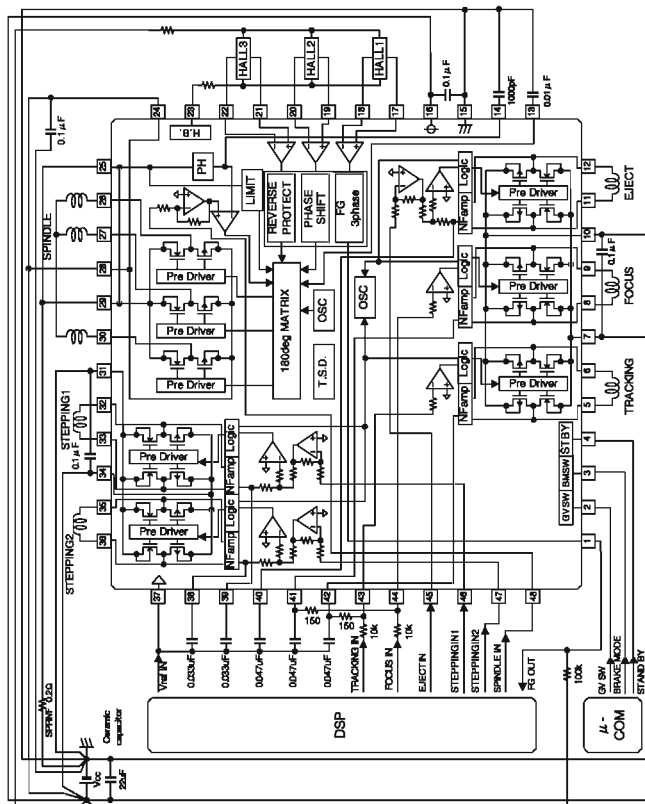

● Electrical characteristic curves

Power supply voltage characteristics

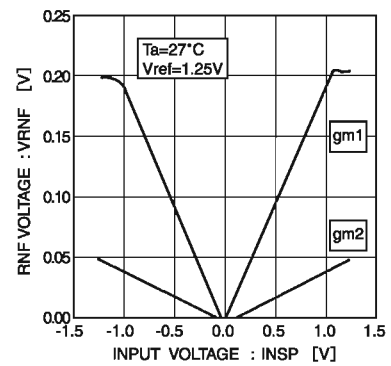
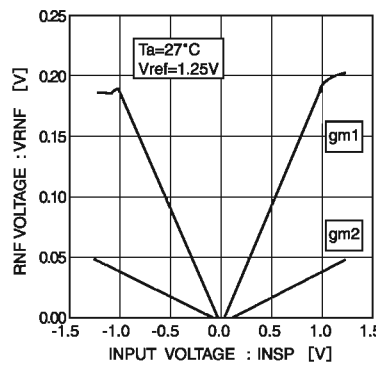
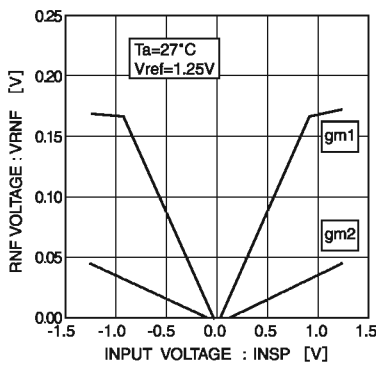
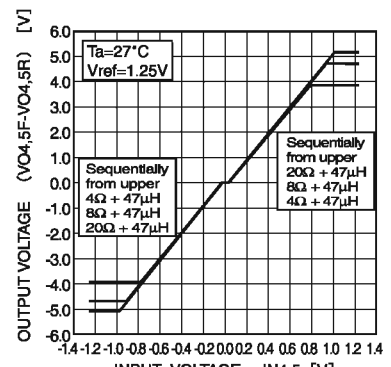
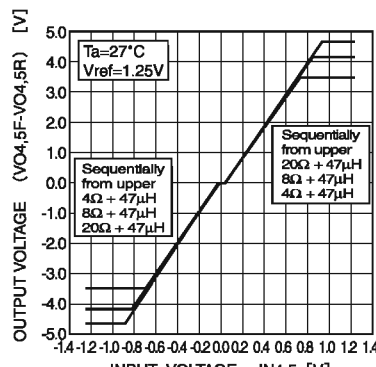
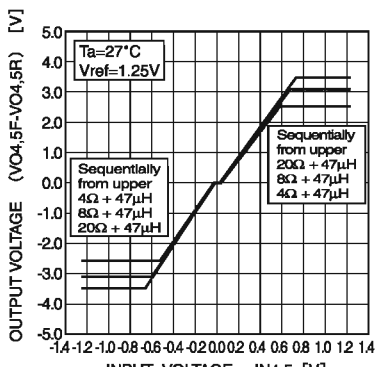
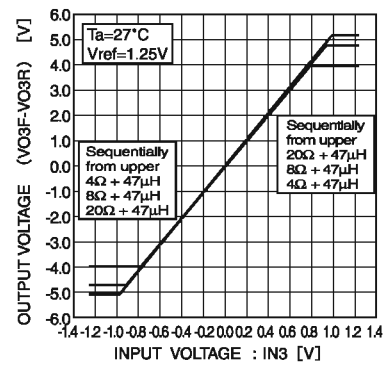
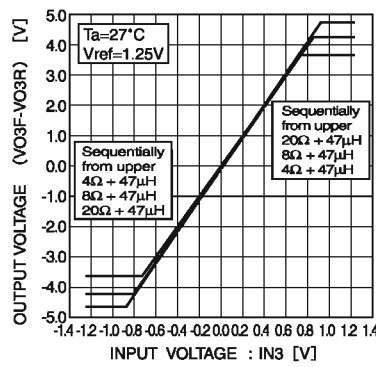
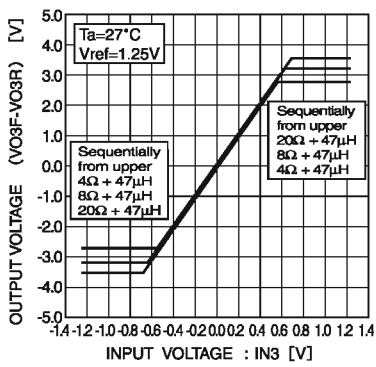
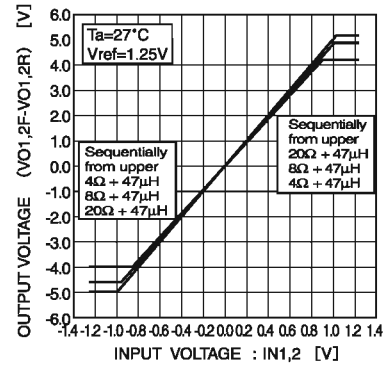
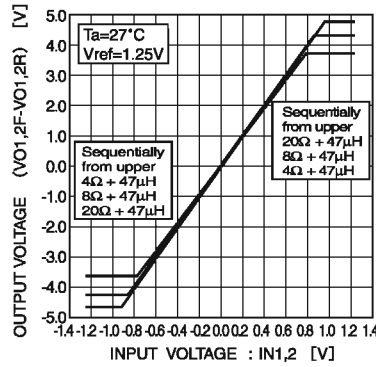
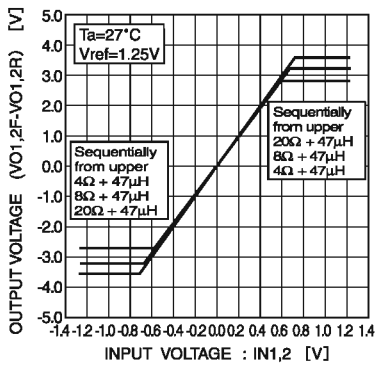

Temperature characteristics

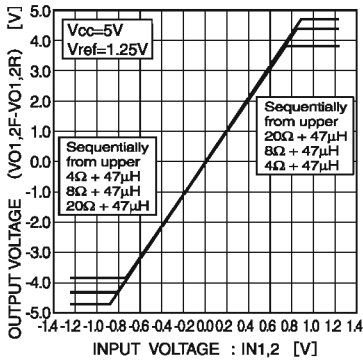

Fig. 13 CH1, 2 I/O characteristic : $T_a = -40^\circ\text{C}$

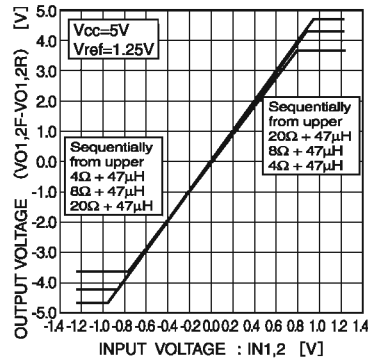

Fig. 14 CH1, 2 I/O characteristic : $T_a = 27^\circ\text{C}$

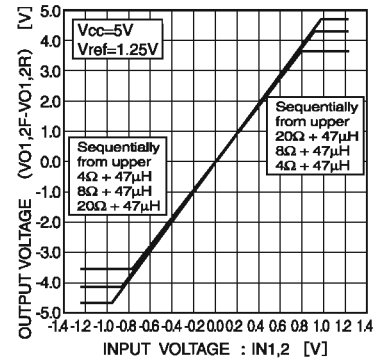

Fig. 15 CH1, 2 I/O characteristic : $T_a = 90^\circ\text{C}$

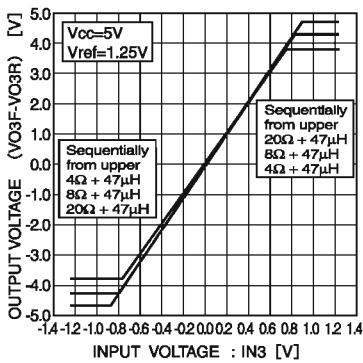

Fig. 16 CH3 I/O characteristic : $T_a = -40^\circ\text{C}$

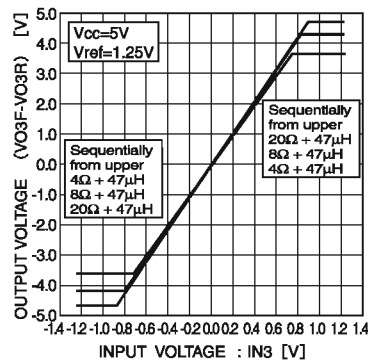

Fig. 17 CH3 I/O characteristic : $T_a = 27^\circ\text{C}$

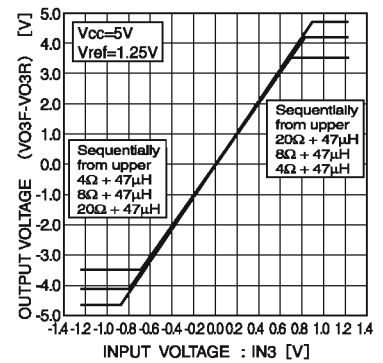

Fig. 18 CH3 I/O characteristic : $T_a = 90^\circ\text{C}$

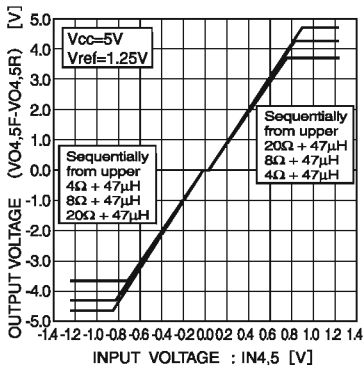

Fig. 19 CH4, 5 I/O characteristic : $T_a = -40^\circ\text{C}$

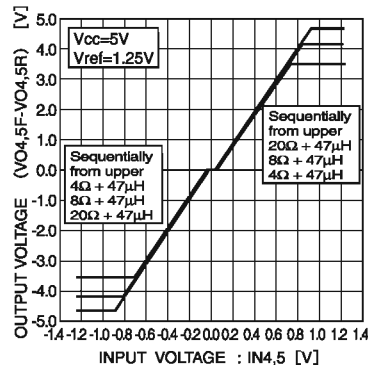

Fig. 20 CH4, 5 I/O characteristic : $T_a = 27^\circ\text{C}$

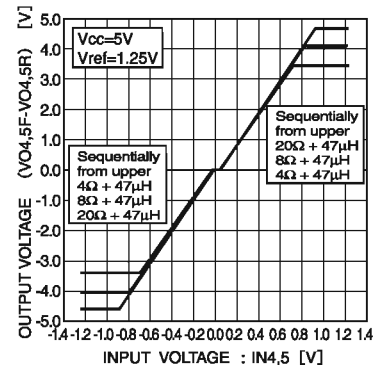

Fig. 21 CH4, 5 I/O characteristic : $T_a = 90^\circ\text{C}$

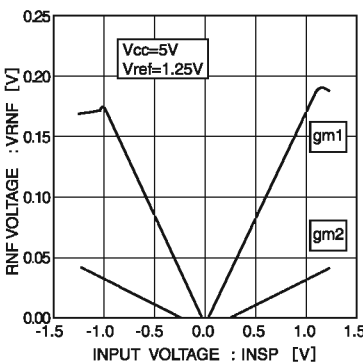

Fig. 22 Spindle driver I/O characteristic : $T_a = -40^\circ\text{C}$

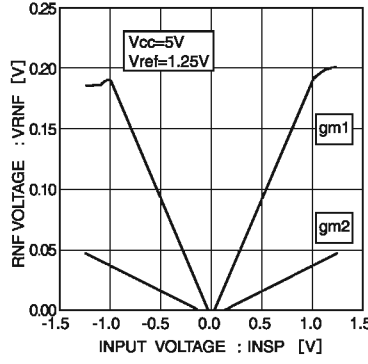

Fig. 23 Spindle driver I/O characteristic : $T_a = 27^\circ\text{C}$

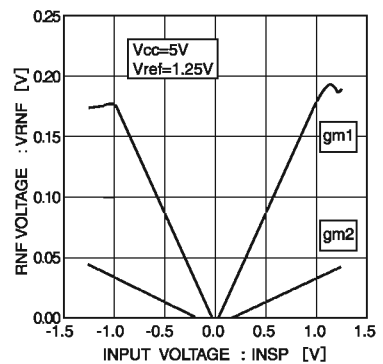
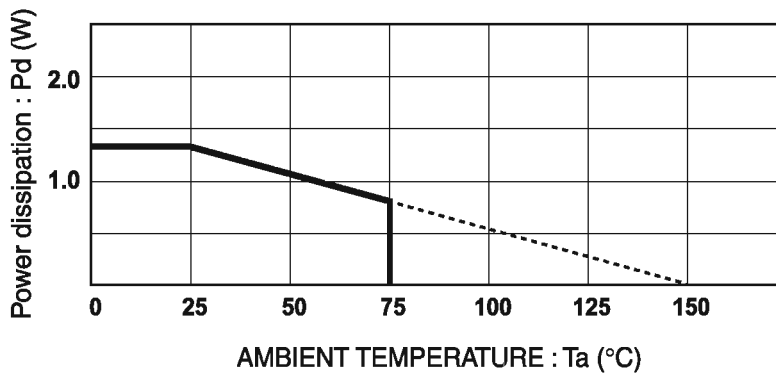

Fig. 24 Spindle driver I/O characteristic : $T_a = 90^\circ\text{C}$

● Power dissipation



* PCB (70mmx70mmx1.6mm, occupied copper foil is less than 3%, glass epoxy) mounting.
Reduce by 11.0mW/°C over 25°C. However, exceed neither Pd nor ASO.

● Order product name selection



ROHM product name Part No. Package type
KVT : TQFP48V

TQFP48V

<Package outlines>

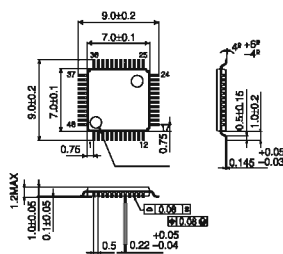

[Unit : mm]

<Tape and Reel information>

(with dry pack)

Tape	Embossed carrier tape (with dry pack)
Quantity	1500pcs
Direction of taping	E2 (The direction is the 1pin of product is at the upper left when you hold reel on the left hand and you pull out the tape on the right hand)

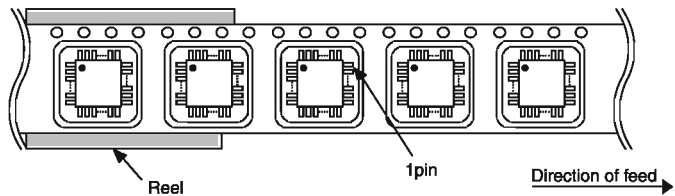

※When you order, please order in times the amount of package quantity.

- The contents described herein are correct as of June, 2006
- The contents described herein are subject to change without notice. For updates of the latest information, please contact and confirm with ROHM CO.,LTD.
- Any part of this application note must not be duplicated or copied without our permission.
- Application circuit diagrams and circuit constants contained herein are shown as examples of standard use and operation. Please pay careful attention to the peripheral conditions when designing circuits and deciding upon circuit constants in the set.
- Any data, including, but not limited to application circuit diagrams and information, described herein are intended only as illustrations of such devices and not as the specifications for such devices. ROHM CO.,LTD. disclaims any warranty that any use of such devices shall be free from infringement of any third party's intellectual property rights or other proprietary rights, and further, assumes no liability of whatsoever nature in the event of any such infringement, or arising from or connected with or related to the use of such devices.
- Upon the sale of any such devices, other than for buyer's right to use such devices itself, resell or otherwise dispose of the same, implied right or license to practice or commercially exploit any intellectual property rights or other proprietary rights owned or controlled by ROHM CO., LTD. is granted to any such buyer.
- The products described herein utilize silicon as the main material.
- The products described herein are not designed to be X ray proof.

The products listed in this catalog are designed to be used with ordinary electronic equipment or devices (such as audio visual equipment, office-automation equipment, communications devices, electrical appliances and electronic toys). Should you intend to use these products with equipment or devices which require an extremely high level of reliability and the malfunction of which would directly endanger human life (such as medical instruments, transportation equipment, aerospace machinery, nuclear-reactor controllers, fuel controllers and other safety devices), please be sure to consult with our sales representative in advance.

Contact us for further information about the products.

Seoul	TEL: +82-2-8182-700	FAX: +82-2-8182-715	Bangkok	TEL: +66-2-254-4890	FAX: +66-2-256-6334
Maastricht	TEL: +82-55-240-6234	FAX: +82-55-240-6236	Kuala Lumpur	TEL: +60-3-7958-8355	FAX: +60-3-7958-8377
Dalian	TEL: +86-411-8230-8549	FAX: +86-411-8230-8537	Penang	TEL: +60-4-6585084	FAX: +60-4-6585167
Beijing	TEL: +86-10-8525-2483	FAX: +86-10-8525-2489	Dusseldorf	TEL: +49-2145-9210	FAX: +49-2154-921400
Tianjin	TEL: +86-22-23029181	FAX: +86-22-23029183	Munich	TEL: +49-8161-48310	FAX: +49-8161-483120
Shanghai	TEL: +86-21-6279-2727	FAX: +86-21-6247-2066	Stuttgart	TEL: +49-711-72723710	FAX: +49-711-72723720
Hangzhou	TEL: +86-571-87658072	FAX: +86-571-87658071	France	TEL: +33-1-5697-3060	FAX: +33-1-5697-3080
Nanjing	TEL: +86-25-8689-0015	FAX: +86-25-8689-0393	United Kingdom	TEL: +44-1-908-306700	FAX: +44-1-908-235788
Ningbo	TEL: +86-574-87654201	FAX: +86-574-87654208	Denmark	TEL: +45-3694-4739	FAX: +45-3694-4789
Qingdao	TEL: +86-532-5779-312	FAX: +86-532-5779-853	Barcelona	TEL: +34-9375-24320	FAX: +34-9375-24410
Suzhou	TEL: +86-512-6807-1300	FAX: +86-512-6807-2300	Malaga	TEL: +34-9520-20283	FAX: +34-9520-20023
Tianjin	TEL: +86-22-23029181	FAX: +86-22-23029183	Hungary	TEL: +36-1-4719338	FAX: +36-1-4719339
Wuxi	TEL: +86-510-82702693	FAX: +86-510-82702992	Poland	TEL: +48-22-5757213	FAX: +48-22-5757001
Hong Kong	TEL: +852-2-740-6262	FAX: +852-2-375-8971	Russia	TEL: +7-95-980-6755	FAX: +7-95-937-8290
Dongguan	TEL: +86-769-393-3320	FAX: +86-769-398-4140	San Diego	TEL: +1-858-625-3630	FAX: +1-858-625-3670
Fuzhou	TEL: +86-591-8801-8698	FAX: +86-591-8801-8690	Atlanta	TEL: +1-770-754-5972	FAX: +1-770-754-0691
Guangzhou	TEL: +86-20-8364-9796	FAX: +86-20-8364-9707	Boston	TEL: +1-978-371-0382	FAX: +1-928-438-7164
Shenzhen	TEL: +86-755-8307-3001	FAX: +86-755-8307-3003	Chicago	TEL: +1-847-368-1006	FAX: +1-847-368-1008
Xiamen	TEL: +86-592-239-8380	FAX: +86-592-239-8380	Dallas	TEL: +1-972-312-8818	FAX: +1-972-312-0330
Zhuhai	TEL: +86-756-3232-480	FAX: +86-756-3232-460	Denver	TEL: +1-303-708-0908	FAX: +1-303-708-0858
Taipei	TEL: +886-2-2500-6956	FAX: +886-2-2503-2869	Nashville	TEL: +1-615-620-6700	FAX: +1-615-620-6702
Kaohsiung	TEL: +886-7-237-0881	FAX: +886-7-238-7332	Guadalajara	TEL: +52-33-3123-2001	FAX: +52-33-3123-2002
Singapore	TEL: +65-6332-2322	FAX: +65-6332-5662			
Manila	TEL: +63-2-807-6872	FAX: +63-2-809-1422			

Excellence in Electronics



ROHM CO., LTD.

21, Saiin Mizosaki-cho, Ukyo-ku, Kyoto
615-8585, Japan
TEL: +81-75-311-2121 FAX: +81-75-315-0172
URL: <http://www.rohm.com>

Notes

No copying or reproduction of this document, in part or in whole, is permitted without the consent of ROHM Co.,Ltd.

The content specified herein is subject to change for improvement without notice.

The content specified herein is for the purpose of introducing ROHM's products (hereinafter "Products"). If you wish to use any such Product, please be sure to refer to the specifications, which can be obtained from ROHM upon request.

Examples of application circuits, circuit constants and any other information contained herein illustrate the standard usage and operations of the Products. The peripheral conditions must be taken into account when designing circuits for mass production.

Great care was taken in ensuring the accuracy of the information specified in this document. However, should you incur any damage arising from any inaccuracy or misprint of such information, ROHM shall bear no responsibility for such damage.

The technical information specified herein is intended only to show the typical functions of and examples of application circuits for the Products. ROHM does not grant you, explicitly or implicitly, any license to use or exercise intellectual property or other rights held by ROHM and other parties. ROHM shall bear no responsibility whatsoever for any dispute arising from the use of such technical information.

The Products specified in this document are intended to be used with general-use electronic equipment or devices (such as audio visual equipment, office-automation equipment, communication devices, electronic appliances and amusement devices).

The Products specified in this document are not designed to be radiation tolerant.

While ROHM always makes efforts to enhance the quality and reliability of its Products, a Product may fail or malfunction for a variety of reasons.

Please be sure to implement in your equipment using the Products safety measures to guard against the possibility of physical injury, fire or any other damage caused in the event of the failure of any Product, such as derating, redundancy, fire control and fail-safe designs. ROHM shall bear no responsibility whatsoever for your use of any Product outside of the prescribed scope or not in accordance with the instruction manual.

The Products are not designed or manufactured to be used with any equipment, device or system which requires an extremely high level of reliability the failure or malfunction of which may result in a direct threat to human life or create a risk of human injury (such as a medical instrument, transportation equipment, aerospace machinery, nuclear-reactor controller, fuel-controller or other safety device). ROHM shall bear no responsibility in any way for use of any of the Products for the above special purposes. If a Product is intended to be used for any such special purpose, please contact a ROHM sales representative before purchasing.

If you intend to export or ship overseas any Product or technology specified herein that may be controlled under the Foreign Exchange and the Foreign Trade Law, you will be required to obtain a license or permit under the Law.



Thank you for your accessing to ROHM product informations.
More detail product informations and catalogs are available, please contact us.

ROHM Customer Support System

<http://www.rohm.com/contact/>