

Package : VCSP50L1

(A table of contents)

1. Structure and materials	1/4 page
2. Tape and Reel information	1/4 to 3/4 page
3. Storage conditions	3/4 page
4. Marking lot number	3/4 page
5. Soldering conditions	3/4 page
6. Footprint dimensions	4/4 page
7. External dimensions	4/4 page
8. Precautions	4/4 page

1. Structure and materials

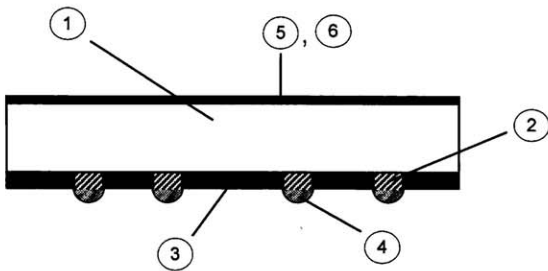

Fig. 1 Structure

No.	Item	Materials
①	Die	Silicon
②	Cu Post	Cu
③	Mold Compound	Epoxy Resin
④	Ext. terminal	Sn-3Ag-0.5Cu Solder
⑤	Mold Compound	Polyamide-imide Resin
⑥	Marking	Laser Marking

Dehydrated weight : 1.5mg

2. Tape and Reel information

2. 1. Packing specification

Tape	Embossed carrier tape
Quantity	3,000pcs/Reel
Direction of feed	E2 (See Fig. 2)

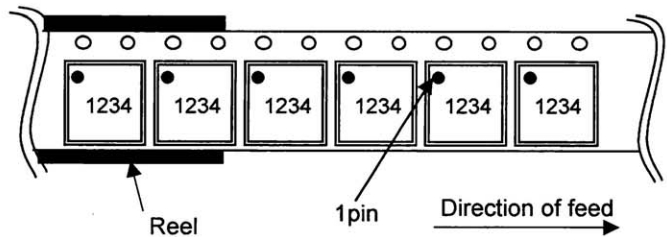

Fig. 2 Typical Tape and Reel configuration

2. 2. Tape and Reel specification

2. 2. 1. Tape and reel dimensions (See the table on page 2/4)

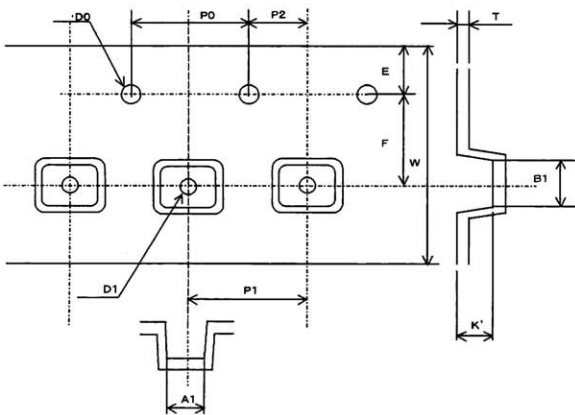

Fig. 3 Tape dimensions

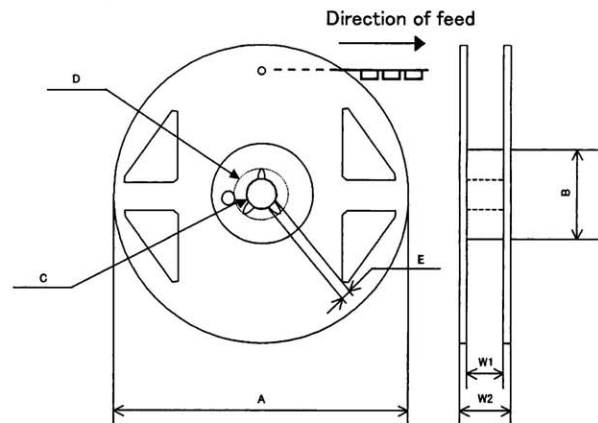

Fig. 4 Reel dimensions

(Tape dimensions)

A1	B1	D0	D1	E	F	K'	P0	P1	P2	T	W
1.70 ±0.1	1.50 ±0.1	φ1.5 +0.1 -0	φ0.5 ±0.1	1.75 ±0.1	3.5 ±0.1	0.85 ±0.1	4.0 ±0.1	4.0 ±0.1	2.0 ±0.1	0.25 ±0.05	8.0 ±0.3

(Reel dimensions)

A	B	C	D	E	W1	W2
φ180 +0 -1.5	60 MIN	φ13.0 ±0.2	φ20.2 MIN	1.5 MIN	9.0 +1.0 -0	11.4 ±1.0

(Unit : mm)

2. 3. Leader and Trailer

2. 3. 1. Leader

No component pockets are 100 pockets(400mm) or more.

2. 3. 2. Trailer

No component pockets are 40 pockets(160mm) or more.

Tape is free from reel.

2. 4. Label for Reel and Box

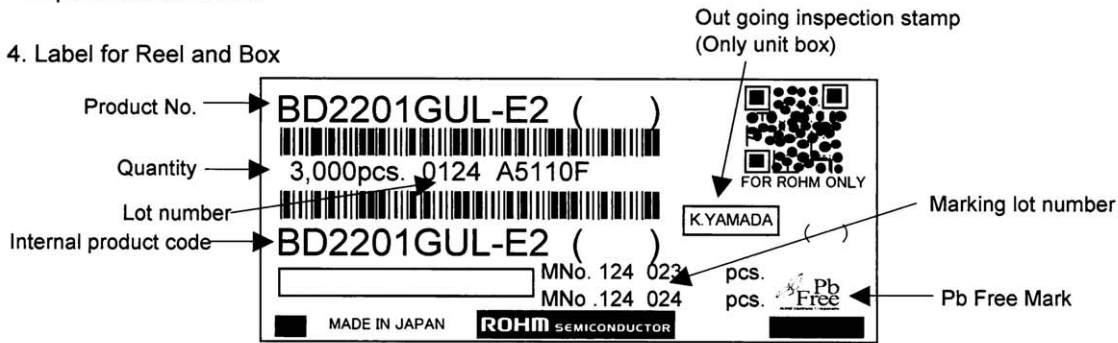

Fig. 5 Label example

2. 5. Packing style

4 reels or less per inner

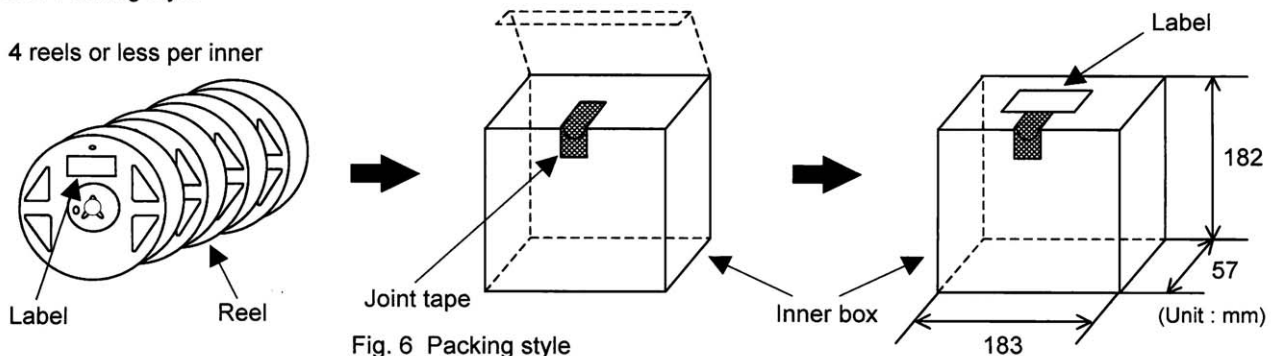

Fig. 6 Packing style

2. 6. Shipping style

4 unit boxes or less per shipping box.

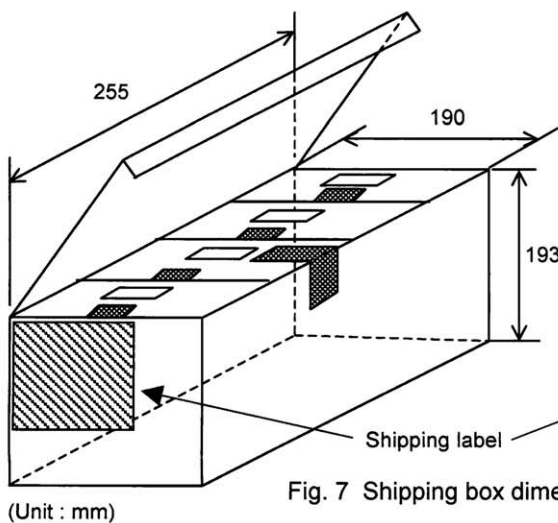

Fig. 7 Shipping box dimensions and shipping style

2.7. Packing materials

Item	Material	Antistatic
Embossed carrier tape	PS	Yes
Cover tape	PET + PE	Yes
Reel	PS	Yes
Unit box	Cardboard	None
Shipping box	Cardboard	None

<Ex.>

NO	PRODUCT CODE	QTY	POD	LOT NO
1	BD2201GUL-E2	48.0	4F28-2885	042147488

48,000 pcs Rank 3 NOC 4

- <Shipping label>
1. Product code
 2. Q' TY
 3. N.O.C
 4. LOT No.

2. 8. Others

2. 8. 1. Peelback strength

Cover tape peelback strength is 0.2 to 0.7N.

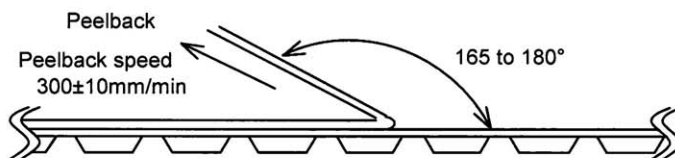

Fig. 8 Test method

2. 8. 2. Missing ICs

(1) No consecutive dropouts.

(2) A maximum 0.1% of specified number of products in each packing may be missing.

3. Storage conditions

3. 1. Storage environment

Recommended storage conditions are as follows :

- Temperature : 5 to 30°C
- Humidity : 40 to 70% RH

3. 2. Storage period

-Specified storage period : 1 year

3. 3. Specified storage period until soldering

This package dose not require additional drying treatment as long as the moisture condition at the mounting process is within our recommended mounting condition.

4. Marking lot number

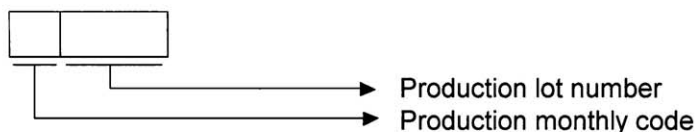

5. Soldering conditions

5. 1. Recommended temperature profile for reflow

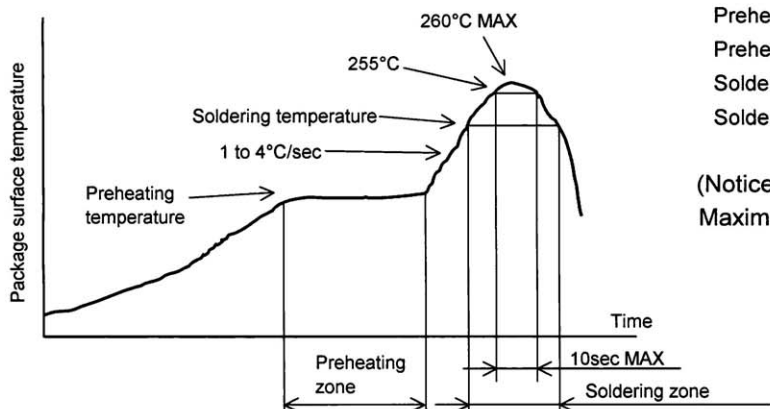

- Preheating temperature ; 130°C to 190°C
- Preheating zone ; 120sec MAX
- Soldering temperature ; 220°C to 230°C
- Soldering zone ; 60sec MAX

(Notice)
Maximum 3-times soldering

5. 2. About mounting with Sn-Pb solder paste.

Mounting with Sn-Pb solder paste is not recommended because it has a possibility of reducing reliability to connect with Sn-3.0Ag-0.5Cu solder balls.

5. 3. The wave soldering method is not supported.

5. 4. Partial heat supply method (by soldering iron) is not supported.

6. Footprint dimensions (Optimize footprint dimensions to the board design and soldering condition)

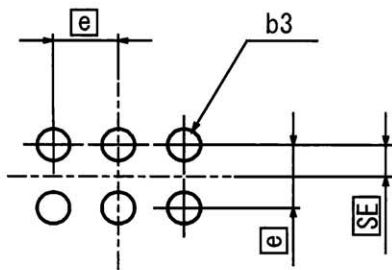

Symbol	Reference Value
e	0.50
b3	Φ0.25
SE	0.25

(Unit : mm)

7. External dimensions

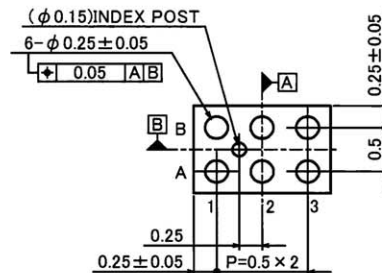
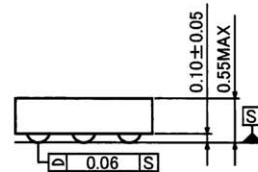
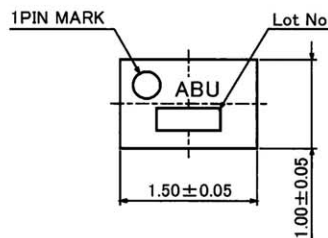

(Unit : mm)

8. Precautions

8. 1. Caution for handling

Silicon substrate surface is exposing to the side of this package.

Therefore, please pay careful attention to chip and crack, and handle without touching the side of package.

8. 2. Regarding the underfill material

In some case, the underfill material is applied in order to reinforce the solder junction of package.

Since there is a case that solder joint reliability may deteriorate according to the resin material or coating condition, please evaluate it sufficiently for its application. In term of the coating condition,

it is preferable that there is an enough material beyond the each four sides of package.

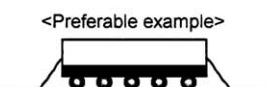

(There is a Underfill resin evenly at each four sides.)

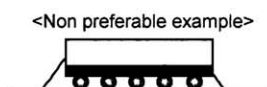

(There is little Underfill resin at one or two sides.)

Notes

No copying or reproduction of this document, in part or in whole, is permitted without the consent of ROHM Co.,Ltd.

The content specified herein is subject to change for improvement without notice.

The content specified herein is for the purpose of introducing ROHM's products (hereinafter "Products"). If you wish to use any such Product, please be sure to refer to the specifications, which can be obtained from ROHM upon request.

Examples of application circuits, circuit constants and any other information contained herein illustrate the standard usage and operations of the Products. The peripheral conditions must be taken into account when designing circuits for mass production.

Great care was taken in ensuring the accuracy of the information specified in this document. However, should you incur any damage arising from any inaccuracy or misprint of such information, ROHM shall bear no responsibility for such damage.

The technical information specified herein is intended only to show the typical functions of and examples of application circuits for the Products. ROHM does not grant you, explicitly or implicitly, any license to use or exercise intellectual property or other rights held by ROHM and other parties. ROHM shall bear no responsibility whatsoever for any dispute arising from the use of such technical information.

The Products specified in this document are intended to be used with general-use electronic equipment or devices (such as audio visual equipment, office-automation equipment, communication devices, electronic appliances and amusement devices).

The Products specified in this document are not designed to be radiation tolerant.

While ROHM always makes efforts to enhance the quality and reliability of its Products, a Product may fail or malfunction for a variety of reasons.

Please be sure to implement in your equipment using the Products safety measures to guard against the possibility of physical injury, fire or any other damage caused in the event of the failure of any Product, such as derating, redundancy, fire control and fail-safe designs. ROHM shall bear no responsibility whatsoever for your use of any Product outside of the prescribed scope or not in accordance with the instruction manual.

The Products are not designed or manufactured to be used with any equipment, device or system which requires an extremely high level of reliability the failure or malfunction of which may result in a direct threat to human life or create a risk of human injury (such as a medical instrument, transportation equipment, aerospace machinery, nuclear-reactor controller, fuel-controller or other safety device). ROHM shall bear no responsibility in any way for use of any of the Products for the above special purposes. If a Product is intended to be used for any such special purpose, please contact a ROHM sales representative before purchasing.

If you intend to export or ship overseas any Product or technology specified herein that may be controlled under the Foreign Exchange and the Foreign Trade Law, you will be required to obtain a license or permit under the Law.



Thank you for your accessing to ROHM product informations.
More detail product informations and catalogs are available, please contact us.

ROHM Customer Support System

<http://www.rohm.com/contact/>