



# SMLXA series

## (PSML-S)

4022(1608)  
4.0×2.2mm(t=2.15mm)

### Features

- High brightness side-view white LEDs
- High heat radiation

Color Type WB

### Specifications

Part No.	Chip Structure	Emitting Color	Absolute Maximum Ratings (Ta=25°C)					Electrical and Optical Characteristics (Ta=25°C)									
			Power Dissipation Pd(mW)	Forward Current If(mA)	Peak Forward Current Ifp(mA)	Reverse Voltage Vr(V)	Operating Temperature Topr(°C)	Storage Temperature Tstg(°C)	Forward Voltage Vf Typ.(V)	Forward Voltage Vf If(mA)	Reverse Current Ir Max.(μA)	Reverse Current Ir Vr(V)	Chromaticity (x, y)	Beam Diameter If(mA)	Luminous Intensity Iv Min.(mcd)	Luminous Intensity Iv Typ.(mcd)	Luminous Intensity Iv If(mA)
<input type="checkbox"/> SMLXA4WBECW(A)	InGaN	White	195	50	100*	5	-40 to +100	-40 to +100	3.2	20	10	5	(0.30, 0.28)	20	1,100	2,100	20
<input type="checkbox"/> SMLXA4WBZTW			114	30	-	-	-	-	-	-	-	(0.31, 0.31)	-	900	1,800	-	

\*Duty1/10, 1kHz

### Dimensions

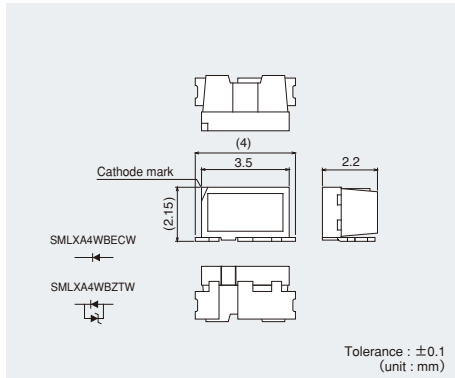

### Recommended Solder Pattern

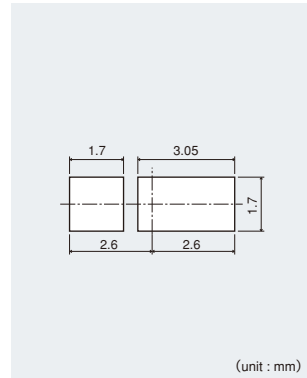

### Viewing Angle

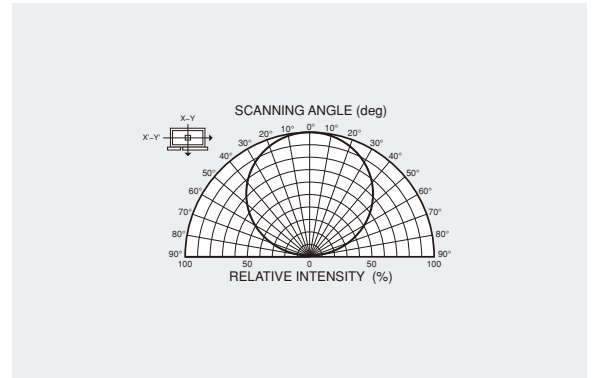

### Electrical Characteristics Curves

#### Forward Current-Forward Voltage

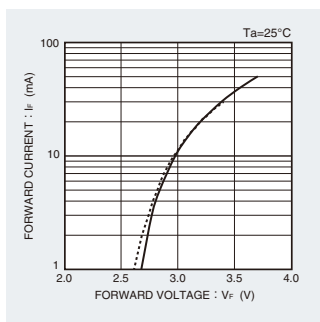

- SMLXA4WBECW(A)
- SMLXA4WBZTW

#### Luminous Intensity-Atmosphere Temperature

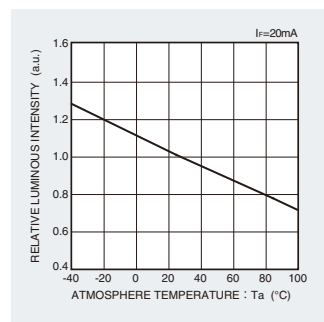

- SMLXA4WBECW(A)
- SMLXA4WBZTW

#### Luminous Intensity-Forward Current

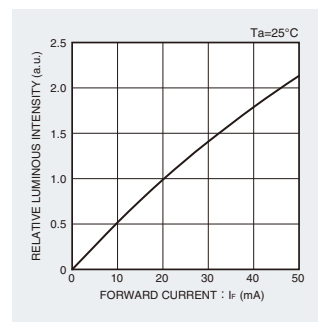

- SMLXA4WBECW(A)
- SMLXA4WBZTW

#### Derating

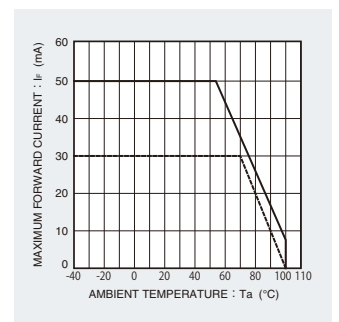

- SMLXA4WBECW(A)
- SMLXA4WBZTW

# SMLXA series

## Rank Reference of Brightness

### White (WB)

Package structure	Package size	Height (mm)	Luminous intensity (mcd) I <sub>F</sub> (mA)	S1	S2	T1	T2	U1	U2	V1	V2	W1	W2	X1	X2	Y1	Y2	Z1	Z2
Side View (Reflector)	4022	2.15	20	90 to	110 to	140 to	180 to	220 to	280 to	360 to	450 to	560 to	710 to	900 to 1100	1100 to 1400	1400 to 1800	1800 to 2200	2200 to 2800	2800 to 3600
<b>SMLXA4WBECW(A)*</b>																			

\* Please note that the brightness of some products may fall between ranks (half rank).

Package structure	Package size	Height (mm)	Luminous intensity (mcd) I <sub>F</sub> (mA)	S	T	U	V	W	X	Y	Z
Side View (Reflector)	4022	2.15	20	90 to	140 to	220 to	360 to	560 to	710 to	1400 to	2200 to 3600
<b>SMLXA4WBZTW</b>											

## Chromaticity Rank

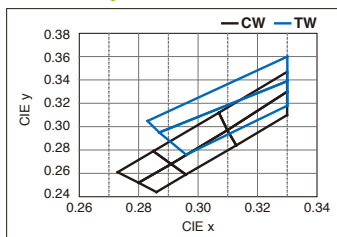

## Part No. Construction

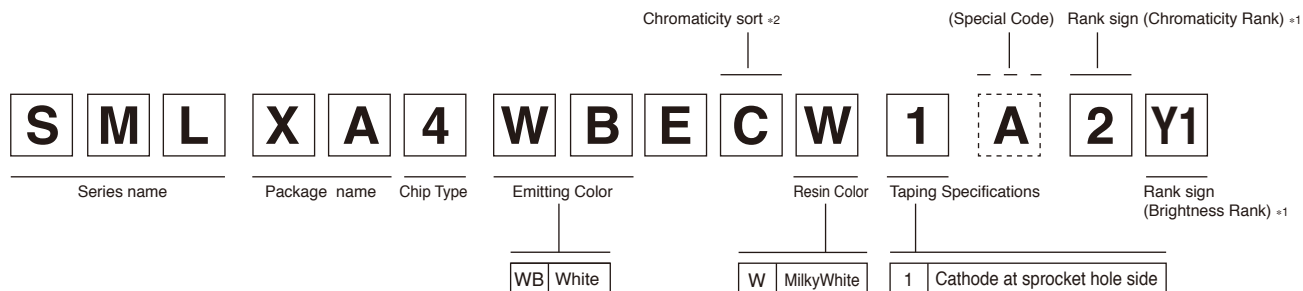

- <sup>=1</sup>: Concerning the Brightness rank
- Please refer to the rank chart above for luminous intensity classification.
  - Please refer to the Specification sheet for color classification.
  - Part name is individual for each rank.
  - When shipped as sample, the part name will be a representative part name.
- General products are free of ranks. Please contact sales if rank appointment is needed.

- <sup>=2</sup>: Please refer to Chromaticity diagram.  
\* Please refer to the Specification sheet about Taping specification.

## Packing Specification

ROHM LED products are being shipped with desiccant (silica gel) included in moisture-proof bags. Pasting the moisture sensitive label on the outer surface of the moisture-proof bags or enclosing the humidity indication card inside the bag is available upon request. Please contact the nearest sales office or distributor if necessary.

## Notes

No copying or reproduction of this document, in part or in whole, is permitted without the consent of ROHM Co.,Ltd.

The content specified herein is subject to change for improvement without notice.

The content specified herein is for the purpose of introducing ROHM's products (hereinafter "Products"). If you wish to use any such Product, please be sure to refer to the specifications, which can be obtained from ROHM upon request.

Examples of application circuits, circuit constants and any other information contained herein illustrate the standard usage and operations of the Products. The peripheral conditions must be taken into account when designing circuits for mass production.

Great care was taken in ensuring the accuracy of the information specified in this document. However, should you incur any damage arising from any inaccuracy or misprint of such information, ROHM shall bear no responsibility for such damage.

The technical information specified herein is intended only to show the typical functions of and examples of application circuits for the Products. ROHM does not grant you, explicitly or implicitly, any license to use or exercise intellectual property or other rights held by ROHM and other parties. ROHM shall bear no responsibility whatsoever for any dispute arising from the use of such technical information.

The Products specified in this document are intended to be used with general-use electronic equipment or devices (such as audio visual equipment, office-automation equipment, communication devices, electronic appliances and amusement devices).

The Products specified in this document are not designed to be radiation tolerant.

While ROHM always makes efforts to enhance the quality and reliability of its Products, a Product may fail or malfunction for a variety of reasons.

Please be sure to implement in your equipment using the Products safety measures to guard against the possibility of physical injury, fire or any other damage caused in the event of the failure of any Product, such as derating, redundancy, fire control and fail-safe designs. ROHM shall bear no responsibility whatsoever for your use of any Product outside of the prescribed scope or not in accordance with the instruction manual.

The Products are not designed or manufactured to be used with any equipment, device or system which requires an extremely high level of reliability the failure or malfunction of which may result in a direct threat to human life or create a risk of human injury (such as a medical instrument, transportation equipment, aerospace machinery, nuclear-reactor controller, fuel-controller or other safety device). ROHM shall bear no responsibility in any way for use of any of the Products for the above special purposes. If a Product is intended to be used for any such special purpose, please contact a ROHM sales representative before purchasing.

If you intend to export or ship overseas any Product or technology specified herein that may be controlled under the Foreign Exchange and the Foreign Trade Law, you will be required to obtain a license or permit under the Law.



Thank you for your accessing to ROHM product informations.  
More detail product informations and catalogs are available, please contact us.

## ROHM Customer Support System

<http://www.rohm.com/contact/>