

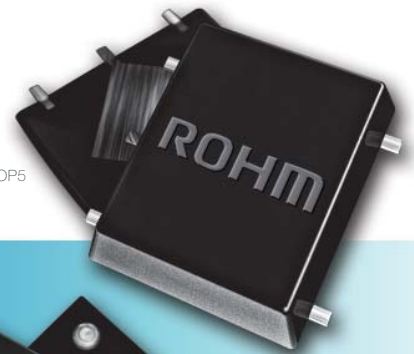

Innovations Embedded



HVSOP5

VOSP60N1



CMOS LDO Regulators

for portable devices

- Mobile Phones
- Camcorders
- PDAs
- Digital Cameras

CMOS LDO Regulators for Portable Devices from ROHM Semiconductor



ROHM CMOS LDO (low drop-out) regulators are tailored for use in portable devices such as PDAs, mobile phones, digital cameras and camcorders. Lower in cost and small in packaging, ROHM CMOS LDOs offer designers a superior alternative to PWM regulators in many point-of-load regulation applications. A complete lineup is available offering designers the ability to optimize the

performance required for the specific task, such as high ripple rejection for analog signal systems or high-speed load regulation for logic circuits. All ROHM CMOS LDOs feature power-saving shutdown capability and all are compatible with space-saving ceramic capacitors.

ROHM CMOS LDOs are available in very small surface mount packages

as well as ultra-small chip-scale units. Depending on the particular model series, these fixed-output devices offer a selection of output voltages ranging from 1.2 V to 3.4 V.

In addition to the wide selection of single-output devices, ROHM offers a series of triple-output models in a compact surface-mount package.

ROHM CMOS LDO Performance Features

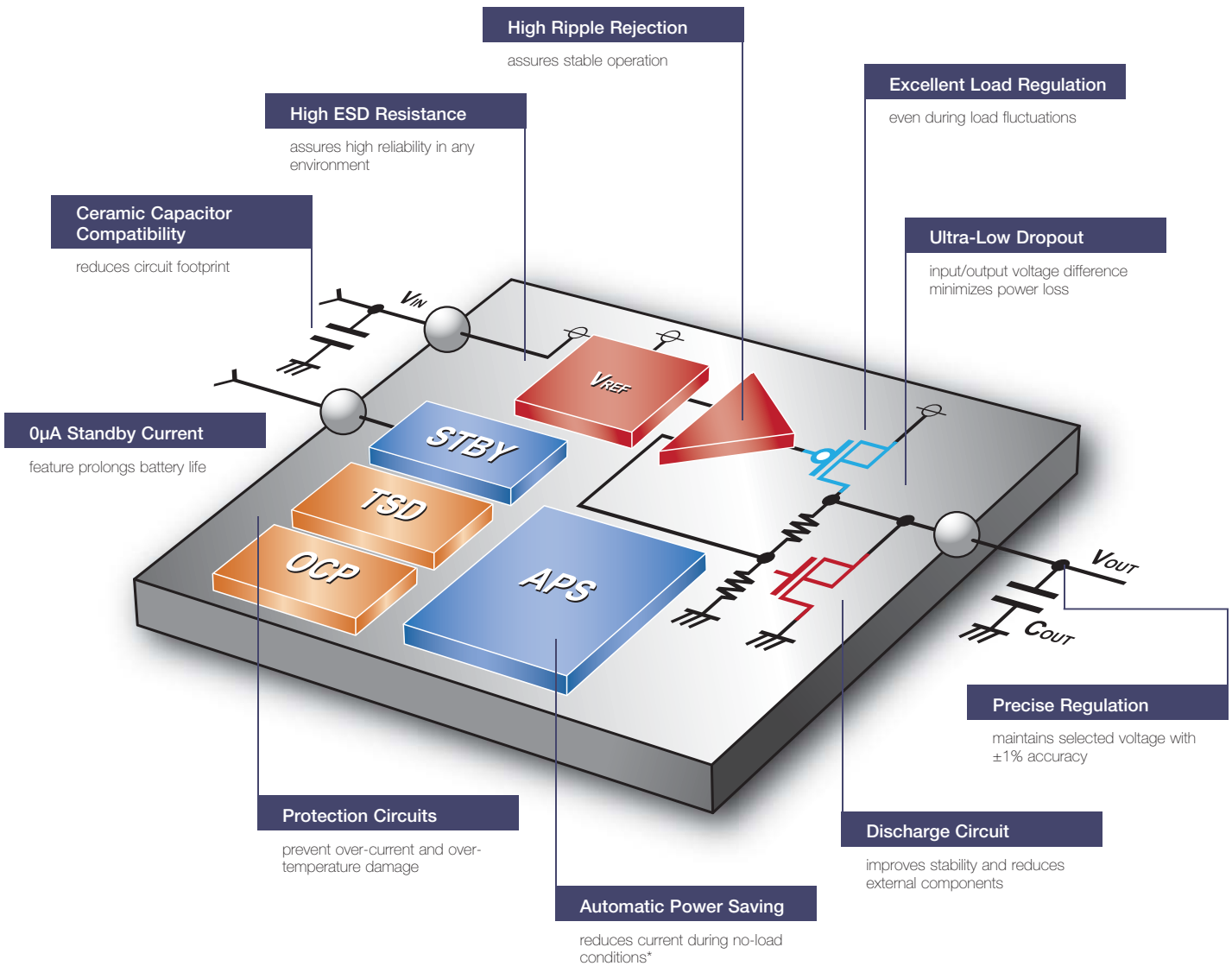

* BH00PB1WHFV

CMOS LDO Regulators for Portable Devices from ROHM Semiconductor



Important Performance Benefits of ROHM CMOS LDOs

Automatic Power Saving Function

ROHM's Automatic Power Saving Function (BHxxPB1 series) switches between a fast response LDO and a Low Power Consumption LDO. Under light load conditions, the operating current is reduced from 20 μA to 2 μA , thereby extending battery life.

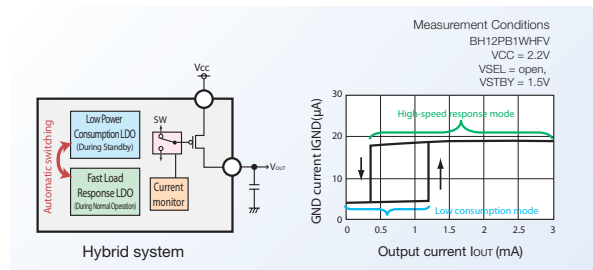

Foldback Overcurrent Protection

ROHM's foldback overcurrent protection provided on all models minimizes the current during abnormal conditions, such as short circuits, preventing damage (along with the integrated thermal shutdown) to both the IC and peripheral circuitry.

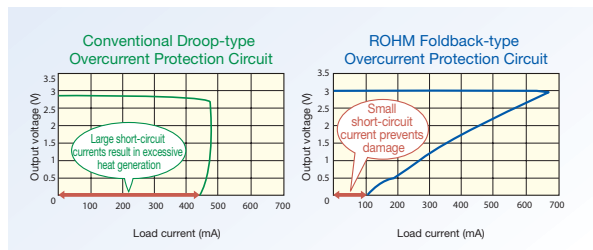

Built-in Phase Compensation

ROHM CMOS LDOs utilize a high-performance amplifier along with optimized phase compensation circuitry to provide exceptional ripple rejection performance – up to 70 dB (for BHxxLB1 and BHxxFB1 series) and higher (80 dB for BHxxNB1 series.)

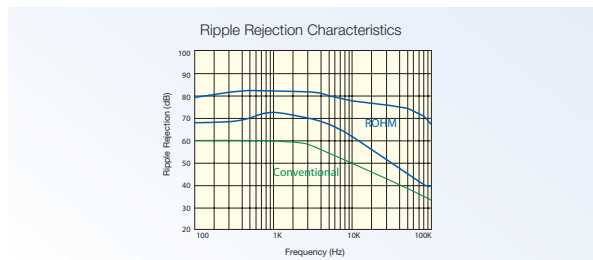

Superior Load Response

ROHM LDOs provide exceptional response to fast load changes. This benefit is fully realized in the performance of ROHM's high-speed load response LDOs (BHxxTA2 series) as compared to conventional units.

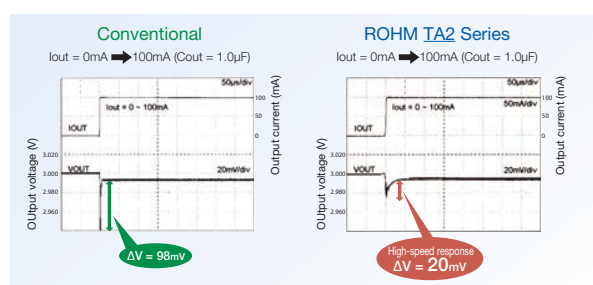

Built-in Discharge Function

ROHM's integrated output capacitor discharge function eliminates the requirement for external blocking diodes to prevent reverse voltage upon shutdown and also ensures stable operation upon startup. This function is available on Automatic Power Saving (BHxxPB1 series) and High-Speed Load Response (BHxxTA2 series) LDOs.

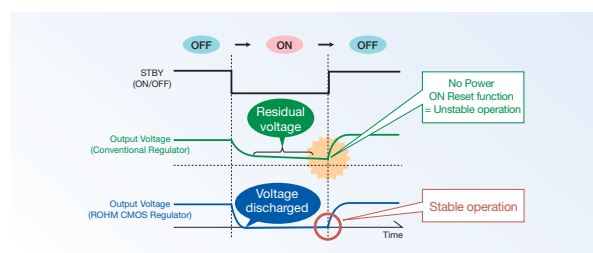

Packaging Solutions of ROHM CMOS LDOs

Compact HVSO5 (LB1/FB1, NB1, PB1 & TA2)

The compact, low profile HVSO5 package is considerably smaller than conventional SC82 or SOT23-5 packages. In addition, the backside heatsink enables power dissipation (P_d) of up to 410 mW. (see Design Note on Page 11)

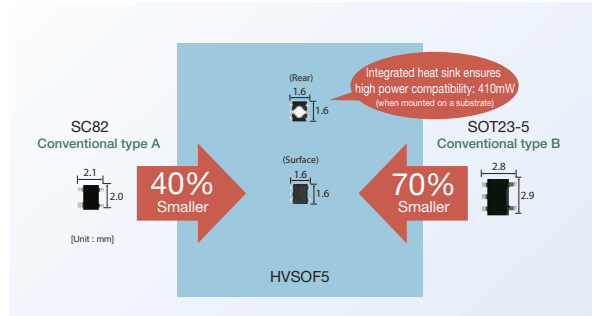

Ultra-Compact VCSP60N1 (RB1 Series)

For the ultimate in space-saving packaging, the VCSP60N1 chip-size package (CSP) is unrivaled. High power dissipation capability (540 mW) and low package height make this part the ideal choice for high-density mounting.

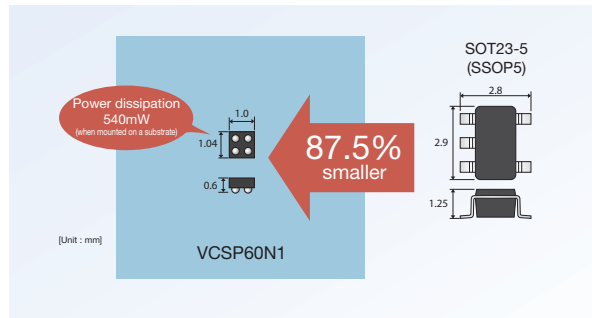

Ultra-Compact SSON004X1216 (TA2 Series)

ROHM's High-Speed Load Response CMOS LDOs are offered in the ultra-compact SSON004X1216 package that features a very small footprint and integrated heatsink and exceptional power dissipation (540 mW).

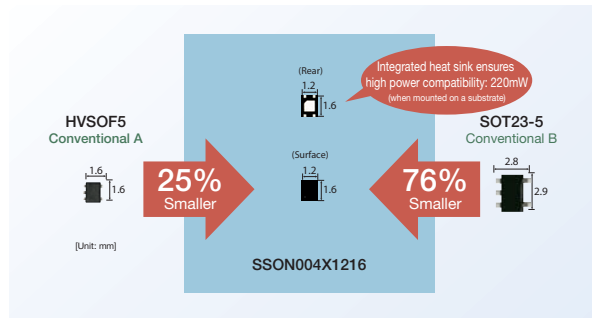

Compact, High-Power HSVOF6 (MA3 Series)

ROHM 300 mA CMOS LDOs (MA3 series and BH6733HFV) are packaged in the HSVOF6 package that provides ample margin against surge currents or overloads and has a backside heatsink capable of dissipating 680 mW.

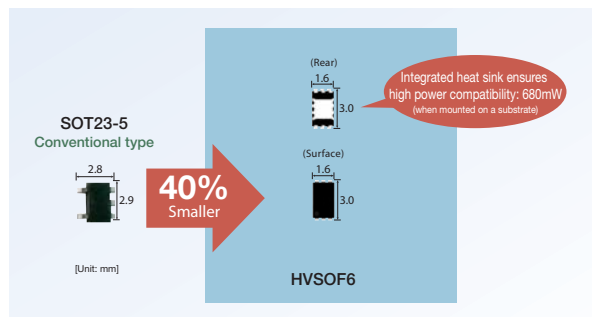

CMOS LDO Regulators

Product Lineup

ROHM
SEMICONDUCTOR

Standard CMOS LDO Regulators

BH□□LB1WG Series												
BH□□LB1WHFV Series												
BH□□FB1WG Series												
BH□□FB1WHFV Series												

300mA Large Current CMOS LDO Regulators

BH□□MA3WHFV Series												
BH6733HFV												

CSP (Chip-Size Package) CMOS LDO Regulators

BH□□RB1WGUT Series												
--------------------	--	--	--	--	--	--	--	--	--	--	--	--

High Ripple Rejection CMOS LDO Regulators

BH□□NB1WHFV Series										
--------------------	--	--	--	--	--	--	--	--	--	--

CMOS LDO Regulators with Automatic Power Saving Function

BH□□PB1WHFV Series												
--------------------	--	--	--	--	--	--	--	--	--	--	--	--

High Speed Load Response CMOS LDO Regulators

BH□□TA2WNVX Series													
BH□□TA2WHFV Series													

Triple Output CMOS LDO Regulators

BU665□NWX Series												
------------------	--	--	--	--	--	--	--	--	--	--	--	--

Key

Ultra small surface mount package	With a shutdown switch	Temperature protection circuit built-in	Automatic power save function
Small surface mount package	Output current	Compatible with compact ceramic capacitors	High-speed load response
Compact power surface mount package	Low operating current	Voltage tolerance	Output discharge function built-in
Output voltage 2.5V~3.3V	Ultra-compact chip scale package	Standby current	Soft start function
Output voltage 1.2V~1.85V	5kV/6kV/8kV ESD resistance	Ripple rejection 60dB/63dB/65dB/70dB/80dB	
Triple output	Overcurrent protection circuit	Low saturation voltage 60mV/100mV	

CMOS LDO Regulators for Portable Devices from ROHM Semiconductor



Standard CMOS LDO Regulators (BHxxLB1 & BHxxFB1 Series)

ROHM's LB1 series of standard CMOS LDOs features 150 mA output and high output voltage accuracy ($\pm 1\%$). Advanced BiCMOS process technology ensures low current consumption (40 μA) and high ripple rejection (70 dB).

Important Features

- Nine output voltages from 1.5 to 3.3 V, including 1.85 V (see page 12 for details)
- 1% output accuracy (FB1); ± 25 mV (LB1)
- 150 mA output current
- 70 dB ripple rejection
- 5 kV ESD protection
- 40 μA circuit current (see Figure 1)
- Ceramic capacitor compatibility (see Design Note below)
- Overcurrent protection — foldback type (50 mA)
- Thermal shutdown
- Standby feature
- STBY input - 0 μA current in standby mode
- Two package options:
Standard SSOP5 (540 mW dissipation)
Compact, low-profile (0.6 mm) HVSO5 (410 mW dissipation)
(see package details on page 3)

BiCMOS Output Stage

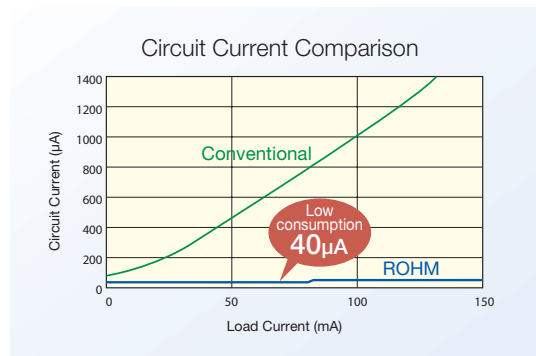

Figure 1. The P-channel MOSFET at the output stage of ROHM's line of Standard CMOS LDOs results in a dramatically lower circuit current than possible with convention bipolar types.

DESIGN NOTE

Ceramic Capacitors

DC Bias Voltage vs. Ceramic Capacitor Capacitance
(characteristic example)

The capacitance of ceramic capacitors may decrease due to temperature fluctuations or DC bias making capacitor selection especially important. It is imperative that the minimum capacitance of both the input and output capacitor be confirmed as part of the circuit design.

CMOS LDO Regulators for Portable Devices from ROHM Semiconductor

300 mA CMOS LDO Regulators (BHxxMA3 Series / BH6733)

ROHM's MA3 series of high current LDOs regulators features 300 mA output current rating, $\pm 1\%$ output voltage accuracy; 6 mV load regulation and a minimum input/output voltage difference of just 60 mV. The Model BH6733HFV, 3.3 V output LDO, offers the same 300 mA current rating and features soft start and output discharge functions as well.

Important Features

- Eight output voltages from 1.5 to 3.3 V (see page 12 for details)
- 1% output accuracy (± 25 mV for 1.5 V and 1.8 V output models & $\pm 2\%$ for BH6733HFV)
- 300 mA output current
- 60 dB ripple rejection (70 dB for BH6733HFV)
- 6 kV ESD protection (8 kV for BH6733HFV)
- 65 μ A circuit current (90 μ A for BH6733HFV)
- 6 mV load regulation (MA3 series)
- 60 mV minimum input/output differential (MA3 series) – see Figure 2
- Ceramic capacitor compatibility (see Design Note on page 5)
- Overcurrent protection – foldback type (100 mA)
- Thermal shutdown
- Standby feature
- STBY input - 0 μ A in standby mode
- Integrated soft start and discharge functionality – see Figure 3 (BH6733HFV only)
- HVSO6 high power dissipation with integrated heat sink – 680 mW
- Low package profile – 0.75 mm
- Low (0.6 ohm) ON resistance internal FET
- Dual output terminals

Low Input/Output Voltage Differential

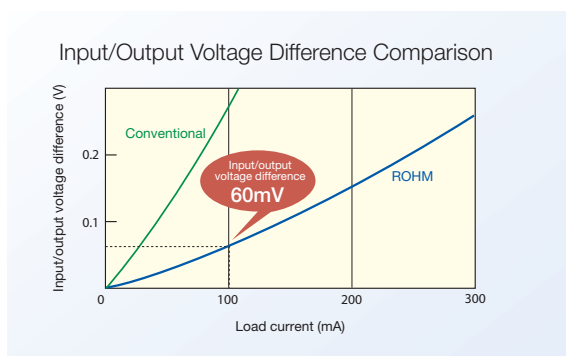

Figure 2. The input output difference of just 60 mV @ 100 mA load current is achieved by optimizing the size of the output transistor for low ON resistance.

Soft Start & Discharge Functions

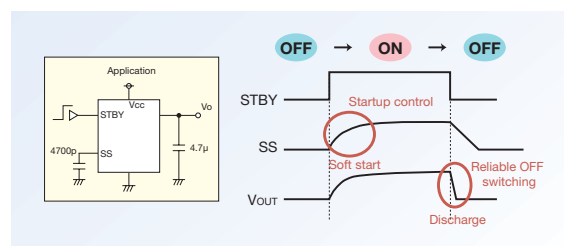

Figure 3. Integrated soft start and output capacitor discharge functionality combine to simplify sequence control.

Chip-Scale Package CMOS LDO Regulators (BHxxRB1 Series)

ROHM's RB1 series of CSP (Chip-Scale Package) CMOS LDOs is optimized for high density mounting in applications like cell phones and digital cameras where both board space and headroom are severely limited.

Important Features

- Eight output voltages from 1.5 to 3.3 V (see page 12 for details)
- 1% output accuracy (± 25 mV for 1.5 V and 1.8 V output models)
- 150 mA output current
- 63 dB ripple rejection
- 5 kV ESD protection
- 34 μ A circuit current (see Figure 6)
- 2 mV load regulation
- STBY input - 0 μ A in standby mode
- 100 mV dropout voltage (see Figure 5)
- Ceramic capacitor compatibility (see Design Note on page 5)
- Overcurrent protection — foldback type (40 mA)
- Thermal shutdown
- Standby feature
- Ultra compact, low-profile 4-pin CSP package (see page 14 for dimensional details)
- Mounting area $1/8$ of SOT23-5 (see Figure 7)
- Excellent power dissipation — 540 mW
- Low package profile — 0.6 mm
- High-reliability CSP construction (see Figure 4)

High-Reliability Packaging

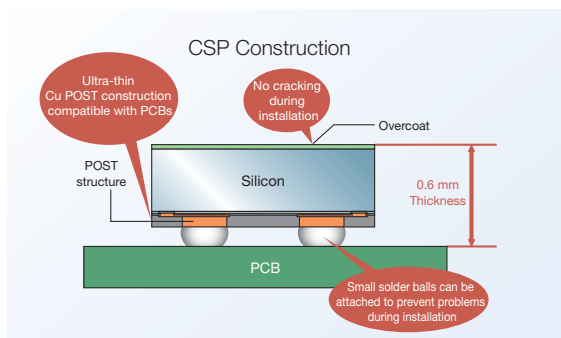

Figure 4. Extra steps are taken to ensure reliable operation and simplify product placement.

Low Input/Output Voltage Differential

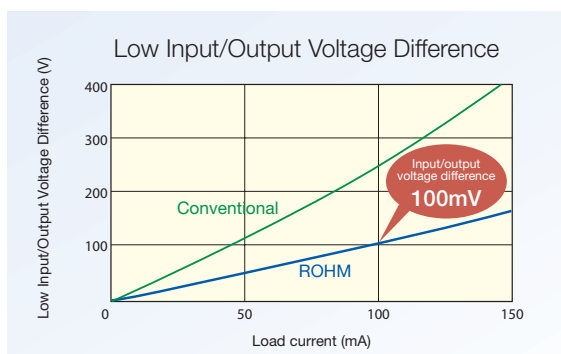

Figure 5. The input output difference of just 100 mV @ 100 mA load current is achieved by optimizing the size of the output transistor for low ON resistance.

BiCMOS Output Stage

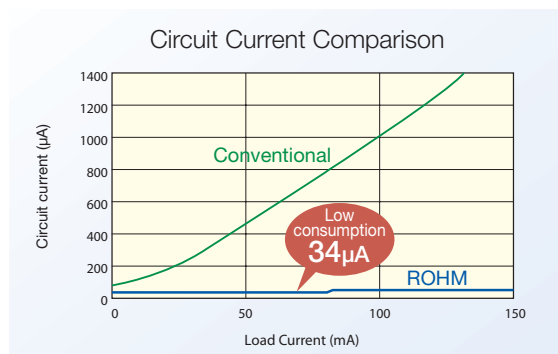

Figure 6. The P-channel MOSFET at the output stage of ROHM's line of Standard CMOS LDOs results in a dramatically lower circuit current than possible with convention bipolar types.

Chip-Scale Package Size Advantage

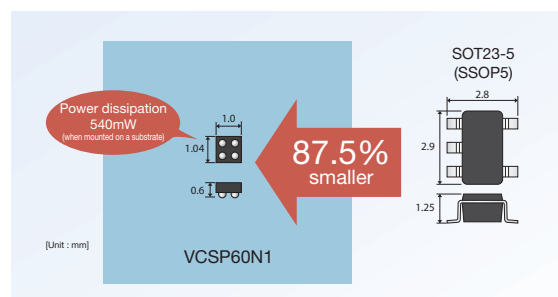

Figure 7. The VCSP60N1 chip-scale package provides the same power dissipation performance as the much larger SOT23-5 package.

High Ripple Rejection CMOS LDO Regulators for High Frequency Circuits (BHxxNB1 Series)

The NB1 series of ROHM CMOS LDOs includes proprietary phase compensation to achieve 80 dB ripple rejection without the use of external filter capacitors. These devices also offer exceptional line and load regulation performance.

Important Features

- Seven output voltages from 2.5 to 3.3 V (see page 12 for details)
- 1% output voltage accuracy
- 150 mA output current
- 80 dB ripple rejection (see Figure 8)
- 6 kV ESD protection
- 60 μ A circuit current (@ $I_o = 100$ mA)
- 6 mV load regulation (see Figure 9)
- 1 mV line regulation (see Figure 9)
- 25 mV load response — ideal for analog circuits
- STBY input - 0 μ A in standby mode
- Ceramic capacitor compatibility (see Design Note on page 5)
- Overcurrent protection — foldback type (50 mA)
- Standby feature
- Thermal shutdown
- Low-profile HVSO5 package — 0.6 mm (see page 14 for dimensional details)
- 70% less mounting space than SOT23-5 (see page 3)

High Ripple Rejection without Filter Capacitors

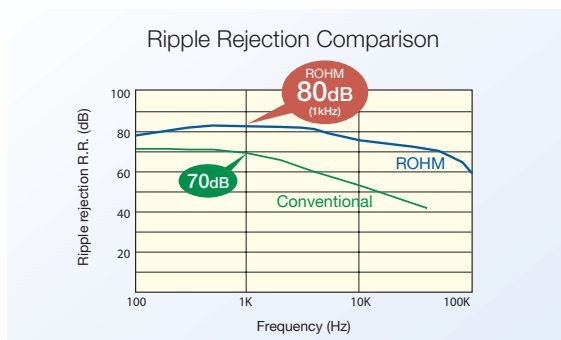

Figure 8. ROHM high ripple rejection LDOs provide rejection ratios of up to 80 dB without the need for the filter capacitors required with conventional regulators provide.

Superior Line and Load Regulation

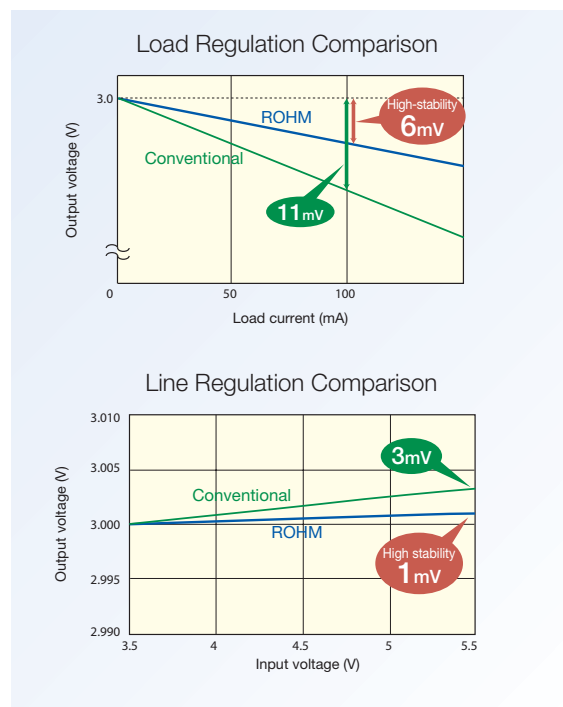

Figure 9. ROHM's proprietary circuitry assures power supply stability with significantly varying load currents or large input voltage variations.

CMOS LDO Regulators with Automatic Power Saving Function (BHxxPB1 Series)

The PB1 series of ROHM LDOs features a hybrid system made up of two LDO circuits that are engaged based upon the current load level, thereby reducing the circuit's current consumption under light load conditions.

Important Features

- Nine output voltages from 1.2 to 3.3 V (see page 13 for details)
- 1% output accuracy (± 25 mV for 1.2 V, 1.5 V and 1.8 V output models)*
- 10 mV load regulation*
- 150 mA output current
- 60 dB ripple rejection*
- 8 kV ESD protection
- Automatic Power Saving (APS) function (see Figure 10)
 - 2 μ A circuit current at no load
 - 20 μ A circuit current (@ $I_o = 100$ mA)
- Very low voltage (1.7 V) input capability (see Figure 11)
- STBY input - 0 μ A in standby mode
- Output discharge function (see page 2)
- Ceramic capacitor compatibility (see Design Note on page 5)
- Overcurrent protection — foldback type (60 mA)
- Standby feature
- Thermal shutdown
- Thermal shutdown and overcurrent protection active in shutdown mode
- Low-profile HVSO5 package — 0.6 mm (see page 14 for dimensional details)
- 70% less mounting space than SOT23-5 (see page 3)
- Inrush current protection

* high-speed mode

Automatic Power Saving Function

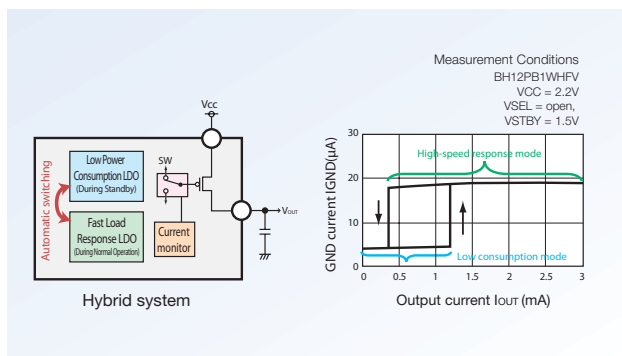

Figure 10. By continuously monitoring the output current, these devices switch between a fast response LDO and a Low Power Consumption LDO. During standby mode in cell phones and other portable devices, the operating current is reduced from 20 μ A to 2 μ A thereby extending battery life.

Very Low Input Voltage

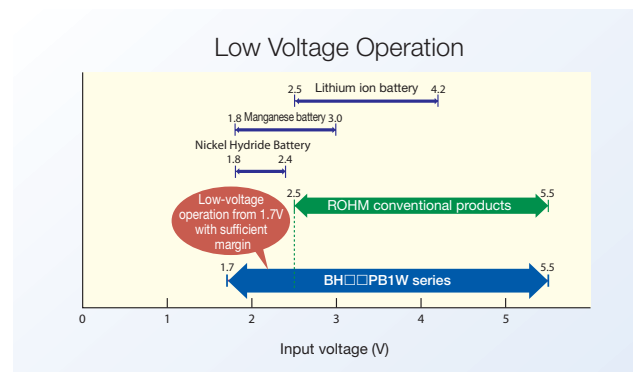

Figure 11. The PB1 series of ROHM CMOS LDOs features the ability to operate from a voltage source as low as 1.7 volts.

High-Speed Load Response Regulators (BHxxTA2 Series)

The TA2 series of CMOS LDOs is specifically designed for high speed digital circuits and offers exceptional dynamic regulation to assure reliable operation during load changes.

Important Features

- Thirteen output voltages from 1.5 to 3.4 V (see page 13 for details)
- 1% output accuracy (± 25 mV for 1.5 V and 1.8 V output models)
- 20 mV load regulation
- 200 mA output current
- 6 kV ESD protection
- 40 μ A circuit current (@ $I_o = 100$ mA)
- STBY input - 0 μ A current in standby mode
- High speed load response (see Figure 12)
- Ceramic capacitor compatibility (see Design Note on page 5)
- Overcurrent protection — foldback type (70 mA)
- Thermal shutdown
- Standby feature
- Discharge function
- Two package options: compact HVSO5 and very compact SSON004X1216
- Low-profile package — 0.6 mm (see page 14 for dimensional details)
- HVSO5 - 70% less mounting space than SOT23-5 (see page 3)
- SSON004X1216- 76% less mounting space than SOT23-5 (see page 3)

High Speed Load Response

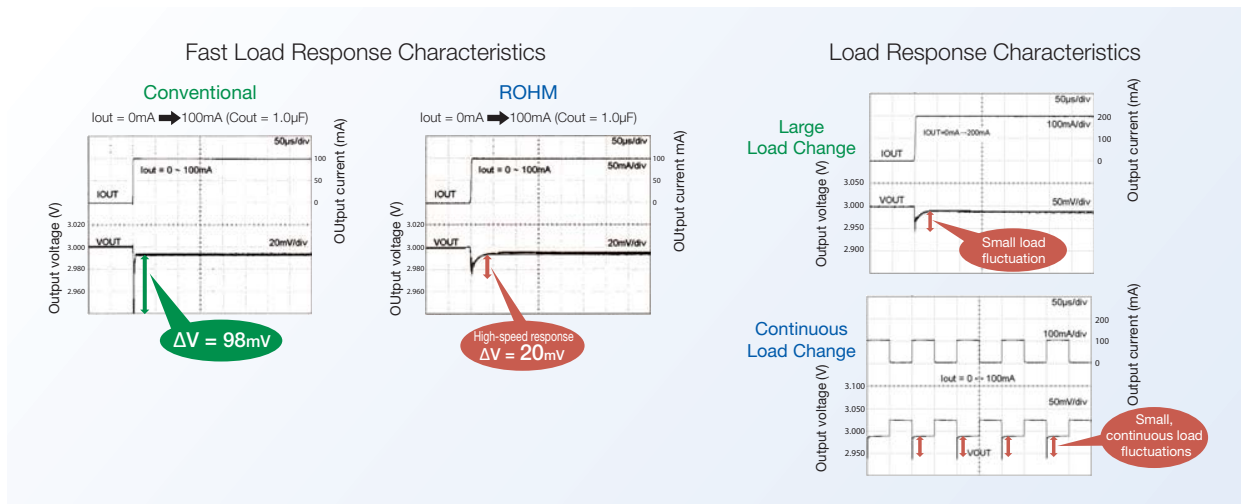

Figure 12. In general, in digital ICs, the current switches from 0 to I_{MAX} and vice versa, synchronized with the clock edge. During operation, if V_{OUT} suddenly drops below the operating range a malfunction could occur. ROHM's line of fast response CMOS LDOs combine a high (200 mA) current rating with exceptional dynamic load regulation.

CMOS LDO Regulators for Portable Devices from ROHM Semiconductor

Triple-Output CMOS LDO Regulators (BU665xNUX Series)

ROHM's BU665xNUX CMOS LDO regulators combine the performance features of the ROHM single-output LDOs in a three-output compact, low-profile package. Several combinations of popular output voltages are available to simplify circuit design to independently regulate voltage to three loads.

Important Features

- Three output voltages (2.8 V, 1.8 V, 1.5 V) (see page 13 for output voltage combinations)
- 1% output voltage accuracy
- 200 mA per channel output current (not to exceed package total power dissipation)
- 70 dB ripple rejection (@ 1.2 V and 1.8 V); 65 dB ripple rejection @ 2.8 V
- 6 kV ESD protection
- 10 mV load regulation
- 1 mV line regulation (see Figure 9)
- STBY input - 1 μ A in standby mode
- Low circuit current (see page 13)
- Ceramic capacitor compatibility (see Design Note on page 5)
- Overcurrent protection — foldback type
- Thermal shutdown
- Independent standby feature for each channel
- Low-profile VSON008X2030 package — 0.6 mm (see page 14 for dimensional details)
- Power dissipation capacity — 660 mW (see Design Note below)

Block Diagram and Application Circuit

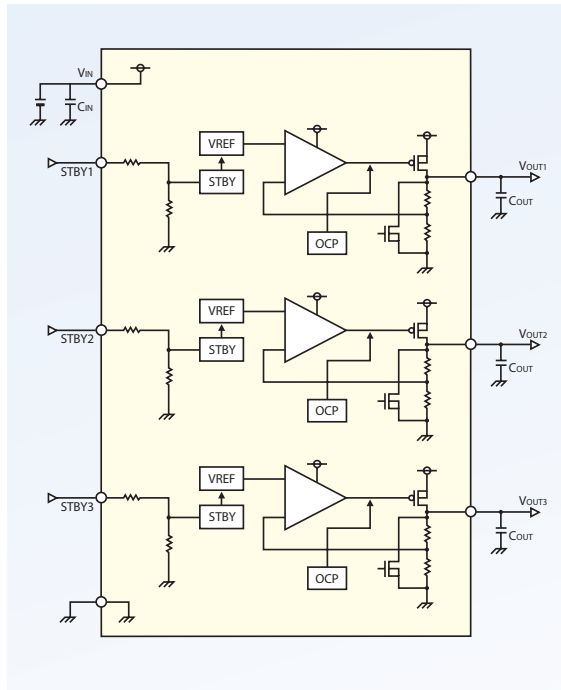

DESIGN NOTE

Power Dissipation

The permissible loss (P_d) will differ depending on the package and board. Using only the specified value may result in unexpected and undesired results.

The first step is to determine the power consumption (P) of the circuit in question:

$$P = (V_{IN} - V_{OUT}) \times I_{OUT}$$

When calculating the permissible loss, ambient temperature and board characteristics (board size, copper foil area) must be taken into consideration.

The published P_d value is based upon operation at 25°C and ROHM "standard" test board, and must be derated as demonstrated in this derating curve.

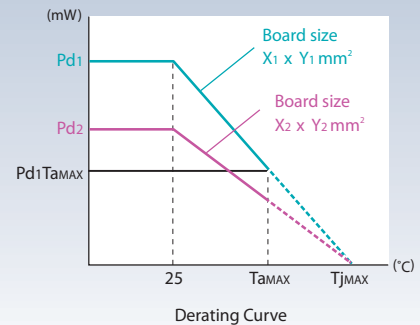

CMOS LDO Regulators

Part Selection Guide

Standard CMOS LDO Regulators

	Part Number		Output Voltage (V)	Output Voltage Accuracy	Output Current (mA)	Supply Voltage (V)	Circuit Current (μ A)	Ripple Rejection (dB)	ESD Resistance (kV)	I/O Voltage Difference (mV)	Load Regulation $I_o=1$ to 100mA (mV)	Input Capacitor (μ F)	Output Capacitor (μ F)	Shutdown Function	Overcurrent Protection Circuit	Thermal Shutdown Circuit
	SSOP5	HVSOF5														
BH15LB1WG SERIES	BH15LB1WG	BH15LB1WHFV	1.5	± 25 mV	150	2.5 to 5.5	40	70	5	-	10	0.1	1.0	•	•	•
	BH18LB1WG	BH18LB1WHFV	1.8	± 25 mV	150	2.5 to 5.5	40	70	5	-	10	0.1	1.0	•	•	•
	BH1JLB1WG	BH1JLB1WHFV	1.85	± 25 mV	150	2.5 to 5.5	40	70	5	-	10	0.1	1.0	•	•	•
BH25FB1WG SERIES	BH25FB1WG	BH25FB1WHFV	2.5	$\pm 1\%$	150	2.5 to 5.5	40	70	5	250*	10	0.1	2.2	•	•	•
	BH28FB1WG	BH28FB1WHFV	2.8	$\pm 1\%$	150	2.5 to 5.5	40	70	5	250*	10	0.1	2.2	•	•	•
	BH29FB1WG	BH29FB1WHFV	2.9	$\pm 1\%$	150	2.5 to 5.5	40	70	5	250*	10	0.1	2.2	•	•	•
	BH30FB1WG	BH30FB1WHFV	3.0	$\pm 1\%$	150	2.5 to 5.5	40	70	5	250*	10	0.1	2.2	•	•	•
	BH31FB1WG	BH31FB1WHFV	3.1	$\pm 1\%$	150	2.5 to 5.5	40	70	5	250*	10	0.1	2.2	•	•	•
	BH33FB1WG	BH33FB1WHFV	3.3	$\pm 1\%$	150	2.5 to 5.5	40	70	5	250*	10	0.1	2.2	•	•	•

* $I_o=100$ mA

300mA Large Current CMOS LDO Regulators

	Part No. HVSOF6	Output Voltage (V)	Output Voltage Accuracy	Output Current (mA)	Supply Voltage (V)	Circuit Current (μ A)	Ripple Rejection (dB)	ESD Resistance (kV)	I/O Voltage Difference (mV)	Load Regulation (mV)	Input Capacitor (μ F)	Output Capacitor (μ F)	Shutdown Function	Overcurrent Protection Circuit	Thermal Shutdown Circuit	Discharge Function	Soft Start Function
	BH18MA3WHFV	1.8	± 25 mV	300	2.5 to 5.5	65	60	6	-	6***	1.0	1.0	•	•	•	•	•
	BH25MA3WHFV	2.5	$\pm 1\%$	300	2.5 to 5.5	65	60	6	60*	6***	1.0	1.0	•	•	•	•	•
	BH28MA3WHFV	2.8	$\pm 1\%$	300	2.5 to 5.5	65	60	6	60*	6***	1.0	1.0	•	•	•	•	•
	BH29MA3WHFV	2.9	$\pm 1\%$	300	2.5 to 5.5	65	60	6	60*	6***	1.0	1.0	•	•	•	•	•
	BH30MA3WHFV	3.0	$\pm 1\%$	300	2.5 to 5.5	65	60	6	60*	6***	1.0	1.0	•	•	•	•	•
	BH31MA3WHFV	3.1	$\pm 1\%$	300	2.5 to 5.5	65	60	6	60*	6***	1.0	1.0	•	•	•	•	•
	BH33MA3WHFV	3.3	$\pm 1\%$	300	2.5 to 5.5	65	60	6	60*	6***	1.0	1.0	•	•	•	•	•
	BH6733HFV	3.3	$\pm 2\%$	300	2.5 to 5.5	90	70	8	700**	20****	4.7	4.7	•	•	•	•	•

* $I_o=100$ mA; ** $I_o=300$ mA; *** $I_o=1$ to 100mA; **** $I_o=1$ to 300mA

CSP (Chip Size Package) CMOS LDO Regulators for High Density Mounting

	Part No. VCSPO8N1	Output Voltage (V)	Output Voltage Accuracy	Output Current (mA)	Supply Voltage (V)	Circuit Current (μ A)	Ripple Rejection (dB)	ESD Resistance (kV)	I/O Voltage Difference (mV)	Load Regulation $I_o=1$ to 100mA (mV)	Input Capacitor (μ F)	Output Capacitor (μ F)	Shutdown Function	Overcurrent Protection Circuit	Thermal Shutdown Circuit
	BH18RB1WGUT	1.8	± 25 mV	150	2.5 to 5.5	34	63	5	-	2	1.0	1.0	•	•	•
	BH25RB1WGUT	2.5	$\pm 1\%$	150	2.5 to 5.5	34	63	5	100*	2	1.0	1.0	•	•	•
	BH28RB1WGUT	2.8	$\pm 1\%$	150	2.5 to 5.5	34	63	5	100*	2	1.0	1.0	•	•	•
	BH29RB1WGUT	2.9	$\pm 1\%$	150	2.5 to 5.5	34	63	5	100*	2	1.0	1.0	•	•	•
	BH30RB1WGUT	3.0	$\pm 1\%$	150	2.5 to 5.5	34	63	5	100*	2	1.0	1.0	•	•	•
	BH31RB1WGUT	3.1	$\pm 1\%$	150	2.5 to 5.5	34	63	5	100*	2	1.0	1.0	•	•	•
	BH33RB1WGUT	3.3	$\pm 1\%$	150	2.5 to 5.5	34	63	5	100*	2	1.0	1.0	•	•	•

* $I_o=100$ mA

High Ripple Rejection CMOS LDO Regulators for High Frequency Circuits

	Part No. HVSOF6	Output Voltage (V)	Output Voltage Accuracy	Output Current (mA)	Supply Voltage (V)	Circuit Current (μ A)	Ripple Rejection (dB)	ESD Resistance (kV)	I/O Voltage Difference (mV)	Load Regulation $I_o=1$ to 100mA (mV)	Input Capacitor (μ F)	Output Capacitor (μ F)	Shutdown Function	Overcurrent Protection Circuit	Thermal Shutdown Circuit
	BH28NB1WHFV	2.8	$\pm 1\%$	150	2.5 to 5.5	60	80	6	250*	6	0.1	2.2	•	•	•
	BH2JNB1WHFV	2.85	$\pm 1\%$	150	2.5 to 5.5	60	80	6	250*	6	0.1	2.2	•	•	•
	BH29NB1WHFV	2.9	$\pm 1\%$	150	2.5 to 5.5	60	80	6	250*	6	0.1	2.2	•	•	•
	BH30NB1WHFV	3.0	$\pm 1\%$	150	2.5 to 5.5	60	80	6	250*	6	0.1	2.2	•	•	•
	BH31NB1WHFV	3.1	$\pm 1\%$	150	2.5 to 5.5	60	80	6	250*	6	0.1	2.2	•	•	•
	BH33NB1WHFV	3.3	$\pm 1\%$	150	2.5 to 5.5	60	80	6	250*	6	0.1	2.2	•	•	•

* $I_o=100$ mA

CMOS LDO Regulators

Part Selection Guide

CMOS LDO Regulators with Automatic Power Saving Function

Part No. HVSOF5	Output Voltage (V)	Output Voltage Accuracy	Output Voltage Accuracy	Output Current (mA)	Supply Voltage (V)	Circuit Current high speed mode (μA)	Circuit Current low consumption mode (μA)	Ripple Rejection high speed mode (dB)	ESD Resistance (kV)	I/O Voltage Difference (mV)	Load Regulation $I_o=10$ to $100mA$ (mV)	Input Capacitor (μF)	Output Capacitor (μF)	Shutdown Function	Overcurrent Protection Circuit	Thermal Shutdown Circuit	Discharge Function
BH12PB1WHFV	1.2	±25mV	-3.3% to +4.3%	150	1.7 to 5.5	20	2	60	8	-	10	0.47	0.47	•	•	•	•
BH15PB1WHFV	1.5	±25mV	-3.3% to +4.3%	150	1.7 to 5.5	20	2	60	8	-	10	0.47	0.47	•	•	•	•
BH18PB1WHFV	1.8	±25mV	-3.3% to +4.3%	150	1.7 to 5.5	20	2	60	8	-	10	0.47	0.47	•	•	•	•
BH25PB1WHFV	2.5	±1%	-3.0% to +3.8%	150	1.7 to 5.5	20	2	60	8	210*	10	0.47	0.47	•	•	•	•
BH28PB1WHFV	2.8	±1%	-3.0% to +3.8%	150	1.7 to 5.5	20	2	60	8	210*	10	0.47	0.47	•	•	•	•
BH29PB1WHFV	2.9	±1%	-3.0% to +3.8%	150	1.7 to 5.5	20	2	60	8	210*	10	0.47	0.47	•	•	•	•
BH30PB1WHFV	3.0	±1%	-3.0% to +3.8%	150	1.7 to 5.5	20	2	60	8	210*	10	0.47	0.47	•	•	•	•
BH31PB1WHFV	3.1	±1%	-3.0% to +3.8%	150	1.7 to 5.5	20	2	60	8	210*	10	0.47	0.47	•	•	•	•
BH33PB1WHFV	3.3	±1%	-3.0% to +3.8%	150	1.7 to 5.5	20	2	60	8	210*	10	0.47	0.47	•	•	•	•

* $(I_o=100mA)$

High Speed Load Response CMOS LDO Regulators

Part Number HVSOF5	Part Number SSON004X1216	Output Voltage (V)	Output Voltage Accuracy	Output Current (mA)	Supply Voltage (V)	Circuit Current (μA)	Ripple Rejection (dB)	ESD Resistance (kV)	I/O Voltage Difference (mV)	Load Regulation $I_o=0.1$ to $200mA$ (mV)	Input Capacitor (μF)	Output Capacitor (μF)	Shutdown Function	Overcurrent Protection Circuit	Thermal Shutdown Circuit	Discharge Function
BU15TA2WHFV	BU15TA2WNVX	1.5	±25mV	200	2.5 to 5.5	40	70	6	-	20	1.0	1.0	•	•	•	•
BU18TA2WHFV	BU18TA2WNVX	1.8	±25mV	200	2.5 to 5.5	40	70	6	-	20	1.0	1.0	•	•	•	•
BU25TA2WHFV	BU25TA2WNVX	2.5	±1%	200	2.5 to 5.5	40	65	6	400	20	1.0	1.0	•	•	•	•
BU26TA2WHFV	BU26TA2WNVX	2.6	±1%	200	2.5 to 5.5	40	65	6	400	20	1.0	1.0	•	•	•	•
BU27TA2WHFV	BU27TA2WNVX	2.7	±1%	200	2.5 to 5.5	40	65	6	360	20	1.0	1.0	•	•	•	•
BU28TA2WHFV	BU28TA2WNVX	2.8	±1%	200	2.5 to 5.5	40	65	6	360	20	1.0	1.0	•	•	•	•
BU2JTA2WHFV	BU2JTA2WNVX	2.85	±1%	200	2.5 to 5.5	40	65	6	360	20	1.0	1.0	•	•	•	•
BU29TA2WHFV	BU29TA2WNVX	2.9	±1%	200	2.5 to 5.5	40	65	6	330	20	1.0	1.0	•	•	•	•
BU30TA2WHFV	BU30TA2WNVX	3.0	±1%	200	2.5 to 5.5	40	65	6	330	20	1.0	1.0	•	•	•	•
BU31TA2WHFV	BU31TA2WNVX	3.1	±1%	200	2.5 to 5.5	40	65	6	330	20	1.0	1.0	•	•	•	•
BU32TA2WHFV	BU32TA2WNVX	3.2	±1%	200	2.5 to 5.5	40	65	6	300	20	1.0	1.0	•	•	•	•
BU33TA2WHFV	BU33TA2WNVX	3.3	±1%	200	2.5 to 5.5	40	65	6	300	20	1.0	1.0	•	•	•	•
BU34TA2WHFV	BU34TA2WNVX	3.4	±1%	200	2.5 to 5.5	40	65	6	300	20	1.0	1.0	•	•	•	•

Triple Output CMOS LDO Regulators

Part No. VSON008X2030	Output Voltage (V)	Output Voltage Accuracy	Output Current (mA)	Supply Voltage (V)	Circuit Current (μA)	Ripple Rejection high speed mode (dB)	I/O Voltage Difference (mV)	Load Regulation $I_o=10$ to $100mA$ (mV)	Input Capacitor (μF)	Output Capacitor (μF)	Shutdown Function	Overcurrent Protection Circuit	Thermal Shutdown Circuit	Discharge Function
BU6650NUX	2.8	+1% / -25mV	200	2.5 to 5.5	40	65	360	10	2.2	1.0	•	•	•	•
	80				65									
	120				70									
BU6651NUX	2.8	+1% / -25mV	200	2.5 to 5.5	40	65	360	10	2.2	1.0	•	•	•	•
	80				70									
	120				70									
BU6652NUX	2.8	+1% / -25mV	200	2.5 to 5.5	40	65	360	10	2.2	1.0	•	•	•	•
	80				65									
	120				70									
BU6653NUX	2.8	+1% / -25mV	200	2.5 to 5.5	40	65	360	10	2.2	1.0	•	•	•	•
	80				70									
	120				70									

CMOS LDO Regulators

Package Dimensions

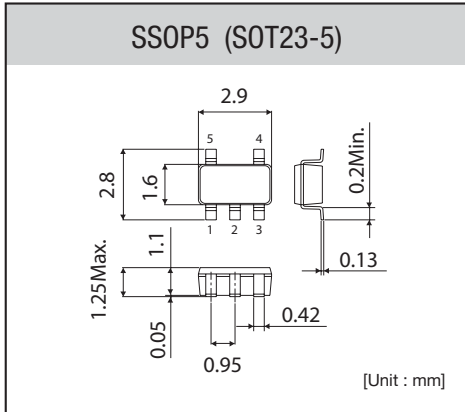

SSOP5: 1 - V_{IN} 4 - NC
 2 - GND 5 - V_{OUT}
 3 - STBY

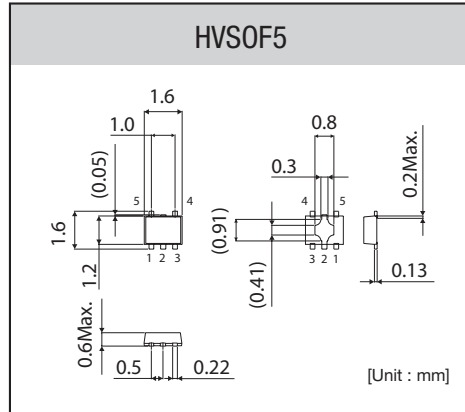

HVSOF5: 1 - STBY 4 - V_{OUT}
 2 - GND 5 - NC
 3 - V_{IN}

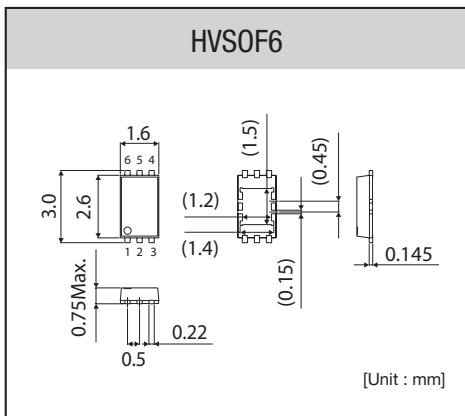

HVSOF6: 1 - V_{IN} 4 - NOISE
 (BHxxMA3WHFV) 2 - V_{OUT} 5 - GND
 3 - V_{OUT} 6 - STBY

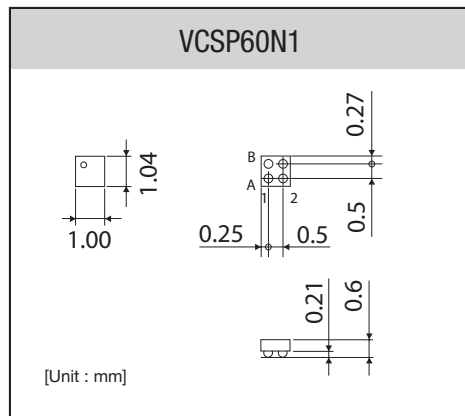

VCSP60N1: A1 - GND B2 - V_{IN}
 A2 - STBY B1 - V_{OUT}

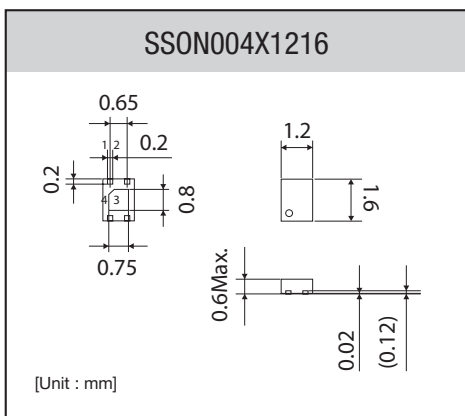

SSON004X1216: 1 - V_{OUT} 3 - STBY
 2 - GND 4 - V_{IN}

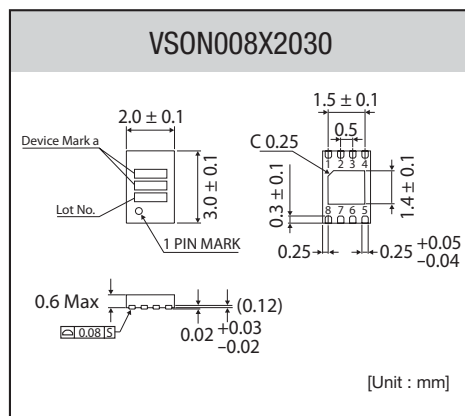

VSON008X2030: 1 - V_{IN} 5 - GND
 2 - STBY1 6 - V_{OUT3}
 3 - STBY2 7 - V_{OUT2}
 4 - STBY3 8 - V_{OUT1}



ROHM SEMICONDUCTOR

10145 Pacific Heights Blvd., Suite 1000
San Diego, CA 92121

www.rohmsemiconductor.com | 1.888.775.ROHM



NOTE: For the most current product information, contact a ROHM sales representative in your area.

ROHM assumes no responsibility for the use of any circuits described herein, conveys no license under any patent or other right, and makes no representations that the circuits are free from patent infringement. Specifications subject to change without notice for the purpose of improvement.

The products listed in this catalog are designed to be used with ordinary electronic equipment or devices (such as audio visual equipment, office-automation equipment, communications devices, electrical appliances and electronic toys). Should you intend to use these products with equipment or devices which require an extremely high level of reliability and the malfunction of which would directly endanger human life (such as medical instruments, transportation equipment, aerospace machinery, nuclear-reactor controllers, fuel controllers and other safety devices), please be sure to consult with our sales representative in advance.

© 2009 ROHM Semiconductor USA, LLC. Although every effort has been made to ensure accuracy, ROHM accepts no responsibility for errors or omissions. Specifications and product availability may be revised without notice. No part of this document represents an offer or contract. Industry part numbers, where specified, are given as an approximate comparative guide to circuit function only. Consult ROHM prior to use of components in safety, health or life-critical systems. All trademarks acknowledged.